

OUTDOOR CATALOG

GREATER THAN YESTERDAY



2024

7' BESTRONG

BESTRONG

GREATER THAN YESTERDAY

DESIGNED AND MANUFACTURED
IN EUROPE

VERSATILE
CONFIGURATIONS

HIGH-QUALITY
MATERIALS

ROBUST SPORTS
EQUIPMENT

ASSEMBLED
WITHIN THE US

STATE-OF-THE-ART
TECHNOLOGY

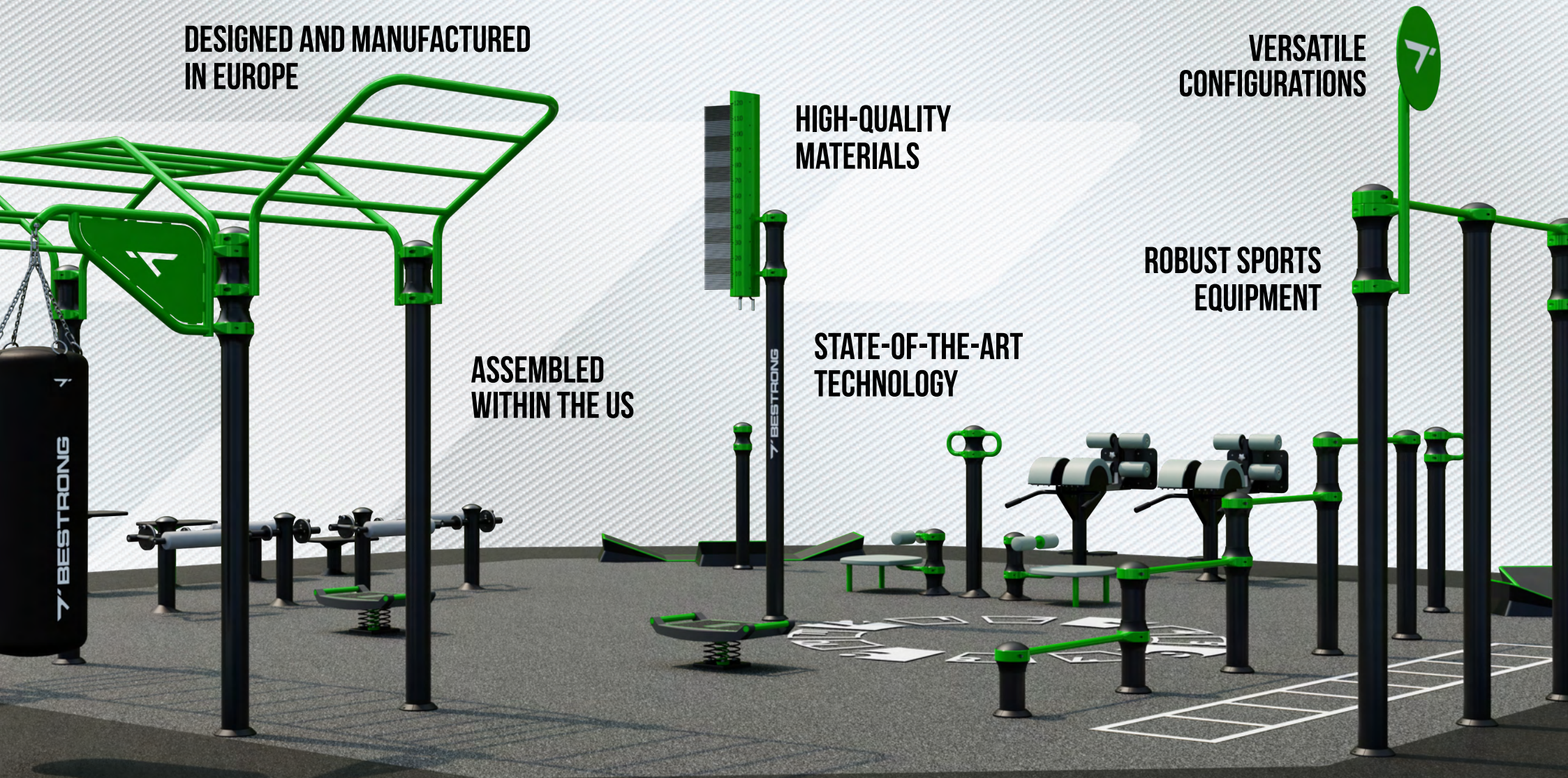

TABLE OF CONTENTS



| | | | | | |
|------------------------------|-------------------------------------|-----------------------------------|--------------------------------|---------------------------------------|-------------------------------------|
| 04 About Us | 09 Designed For Champions | 28 Recreational | 42 Adjustable Weight | 56 Padel | 62 Material Specification |
| 05 BESTRONG U.S.A. | 10 FitCampus | 32 Calisthenics | 44 Soccer Specific | 58 3D & AR | 63 Warranty |
| 06 Mission | 14 FitLiving | 36 Cross-Training | 47 Accessories | 59 Design Your Fitness Park | 64 Contacts |
| 07 Values | 18 FitSociety | 38 Fitness | 50 Sporting Kansas | 60 Craftsmanship | |
| 08 Accomplishments | 24 FitStay | 41 Accessible Equipment | 51 Arenas | 61 Manufacturing | |

Story

In 2007, our owner Zoltán Katona embarked on a journey to Australia for a much-needed vacation. While wandering through the picturesque landscapes of Australia, Zoltán noticed a unique trend that captured his attention – the widespread use of outdoor fitness equipment in parks and public spaces. Intrigued by the idea of combining exercise with the beauty of nature, he saw an opportunity to bring this concept back to Hungary.

The company

KATKER 2005 Ltd, the owner of the BESTRONG brand, has been a prominent player in the Hungarian sports industry for over 20 years. Our company is involved in designing, manufacturing, installing, and selling outdoor and indoor sports equipment, sports parks, sports fields, and outdoor furniture. Our dedicated team of over 80 professionals continuously works to expand our product range, tailoring it to various sports, age groups, and fitness levels.

A world map with a dark background and light gray landmasses. Several regions are highlighted in bright green, including Alaska, the contiguous United States, parts of Europe, Africa, and Asia. Two orange location pins are placed on the map: one in the United States and one in Europe. Dashed yellow lines connect these pins to text boxes. The box on the left contains the text 'BESTRONG USA, INC.' and the box on the right contains 'BESTRONG FACTORY'.

BESTRONG USA, INC.

BESTRONG FACTORY

Vision

Zoltán envisioned BeStrong as more than just a fitness brand. He saw it as a movement that would inspire individuals to break free from sedentary lifestyles, embrace their inner strength, and achieve their full potential. BeStrong's mission was simple yet profound: to make strength accessible to everyone, regardless of their background, fitness level, or age. The story of BeStrong is not just about building muscles. It's about building stronger, more resilient communities, united by the common goal of living life to its fullest potential.

Portfolio

BESTRONG offers a diverse range of products, including sport-specific fitness, cardio, calisthenics, and recreational fitness equipment systems, as well as multifunctional sports fields and arenas. Starting in 2024, we will introduce outdoor adjustable load sports equipment, solutions for people with disabilities, and state-of-the-art padel courts in our portfolio.



USA

After receiving positive feedback and experiencing successful market expansion in Europe, we turned our attention to the lucrative US market. The introduction of our unique, soccer-specific equipment led to a fruitful partnership with Sporting Kansas City, one of the most well-known MLS teams. This partnership will soon result in the construction of our own soccer-specific fitness park and arena at Sporting Kansas City's facility, which will also serve as the home for the U.S. National Soccer Team. This significant milestone marked the establishment of our subsidiary, BESTRONG USA, Inc.

BESTRONG USA, INC.

To solidify our presence in the US market, we planned to build an assembly hall in Port Orange, Florida, with groundbreaking having occurred in the fall of 2023 followed by construction starting in the summer of 2024, a fully equipped BESTRONG office center will be ready to provide high-quality services to our US customers and distributors.



OUR MISSION

Through daily physical activity and outdoor exercise, we strive to educate individuals on how to lead healthy lifestyles. We are dedicated to assisting people in achieving better health, increased strength, and enhanced fitness levels through the use of high-quality sports equipment.

04.

Self-control



06.

Development



05.

Community



VALUES

As a result of recognizing the diverse needs of sports enthusiasts, we continuously develop and improve our products and services. We have great confidence in seeking and incorporating the advice of renowned professionals and athletes in the design of our products. We genuinely value and attentively listen to the communities' perspectives that utilize our sports equipment and parks. Innovation in sports remains one of our top priorities.



INTERNATIONAL EXPERIENCE

We have faith in the unifying power of sports and believe that a shared love for sports brings people together. In addition to our many locations in Hungary, our nearly 2000 sports fields and parks have already been installed in over 27 countries in Europe, Africa, Asia, and North America. Furthermore, we are very proud that athletes attending the 2023 World Athletics Championships took advantage of our training center during the event.



OUR VISION

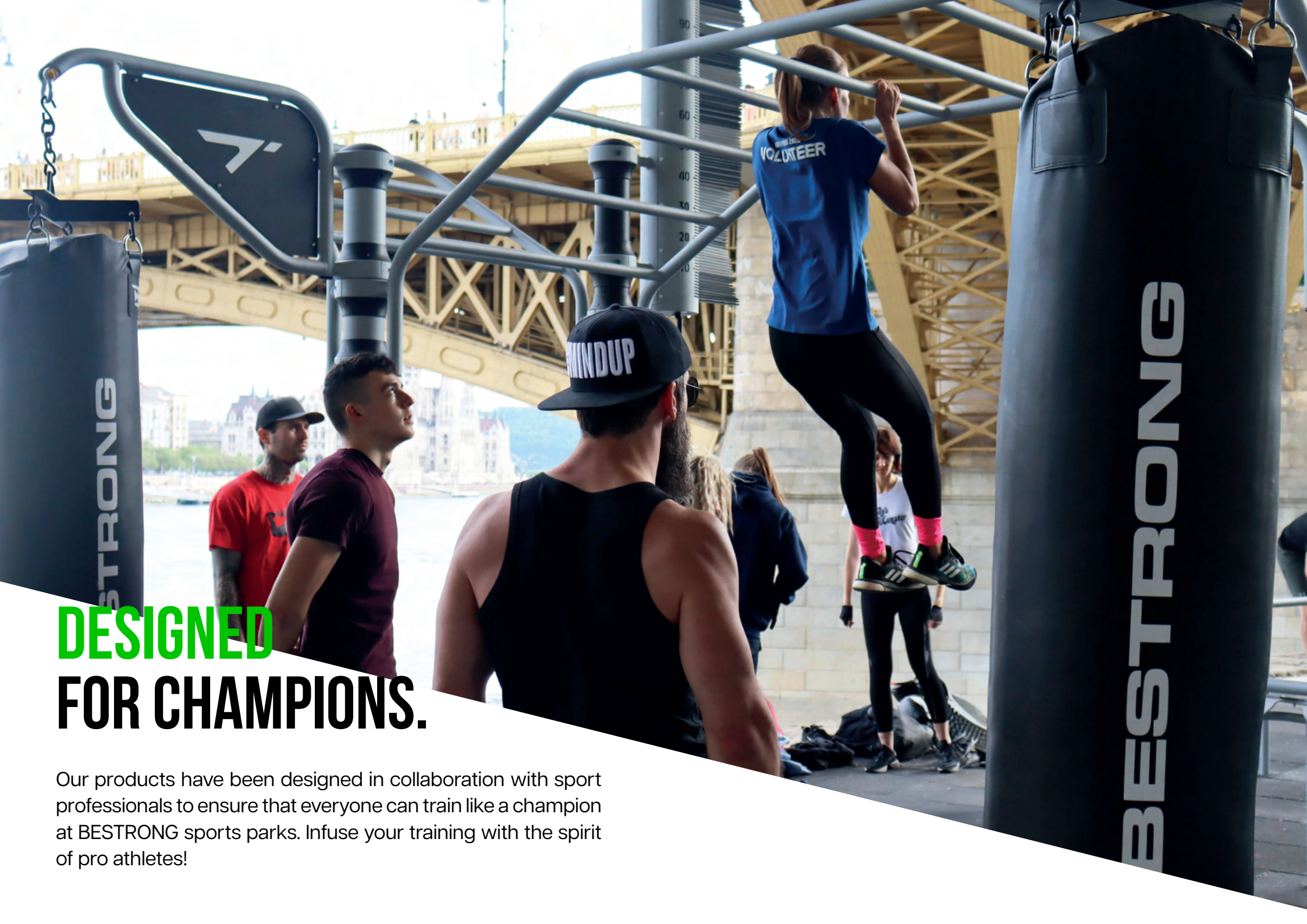

DESIGNED FOR CHAMPIONS.

Our products have been designed in collaboration with sport professionals to ensure that everyone can train like a champion at BESTRONG sports parks. Infuse your training with the spirit of pro athletes!

FITCAMPUS

For the full range of FitCampus

- < click on the QR code, or
- < scan with your mobile device





The BESTRONG FitCampus introduces a new dimension to sports in schools and educational centers. Our sport equipment in this setup promotes an active and health-conscious culture, contributing to the diversification of daily physical education. With FitCampus, you can underscore the significance of physical well-being in a holistic education approach and establish an environment that fosters the balanced development of both body and mind.

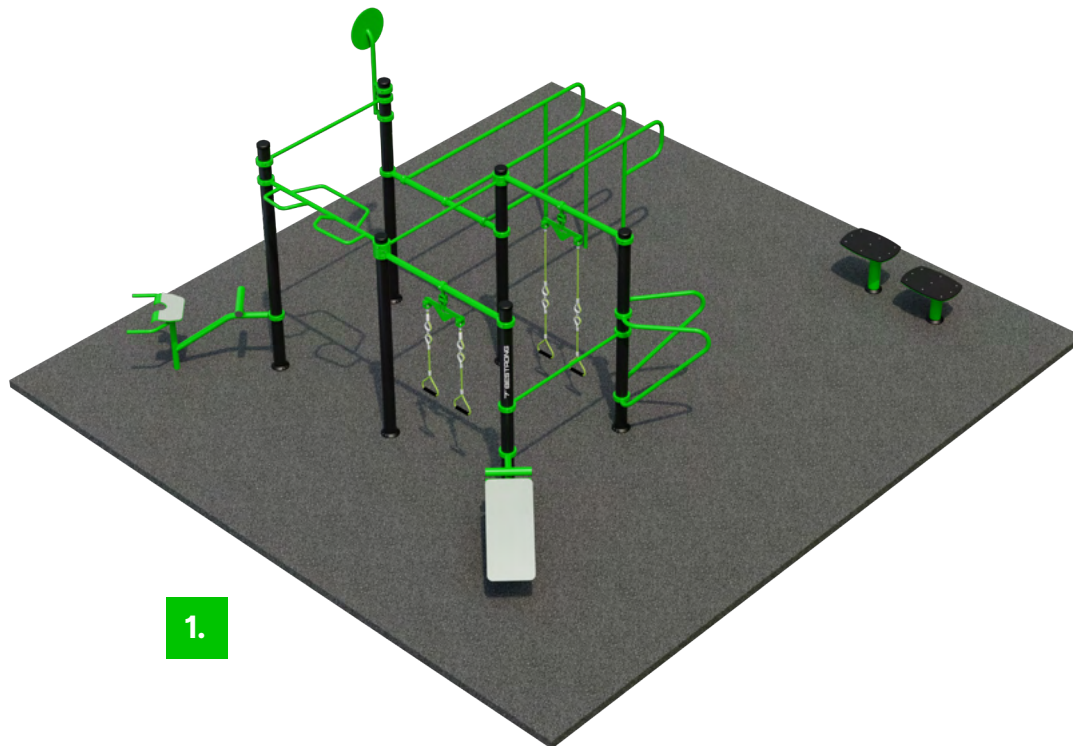

| | ID. | Product Name | Certificate | Age Group | Capacity | Total Area | Number of equipment | Fall height | Net weight |
|----|---------|--------------|----------------------|------------|-----------|-------------------------------------------------|---------------------|--------------|------------|
| 1. | 1-3-233 | FitCampus 1 | EN 16630, ASTM F3101 | 14 + years | 24 people | 565.10 ft ² (24'-7,28" x 22'-11,59") | 12 | 4'-11.06" ft | 1047 lbs |
| 2. | 1-3-261 | FitCampus 3 | EN 16630, ASTM F3101 | 14 + years | 24 people | 1355.8 ft ² (39'-4,44" x 34'-5,39") | 12 | 3.1 ft | 1719.5 lbs |



3.

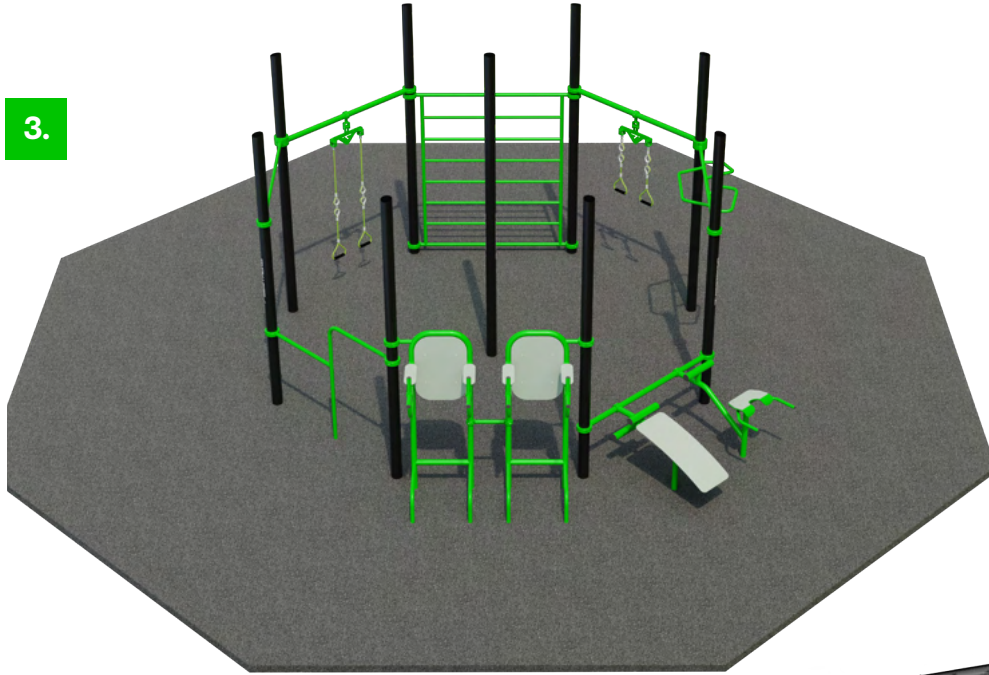

| ID. | Product Name | Certificate | Age Group | Capacity | Total Area | Number of equipment | Fall height | Net weight | |
|-----|--------------|-------------|----------------------|------------|------------|-----------------------------------|-------------|------------|------------|
| 3. | 1-3-243 | FitCampus 2 | EN 16630, ASTM F3101 | 14 + years | 20 people | 960.8 ft' (34'-0,66" x 34'-0,66") | 10 | 6.9 ft | 4108.5 lbs |

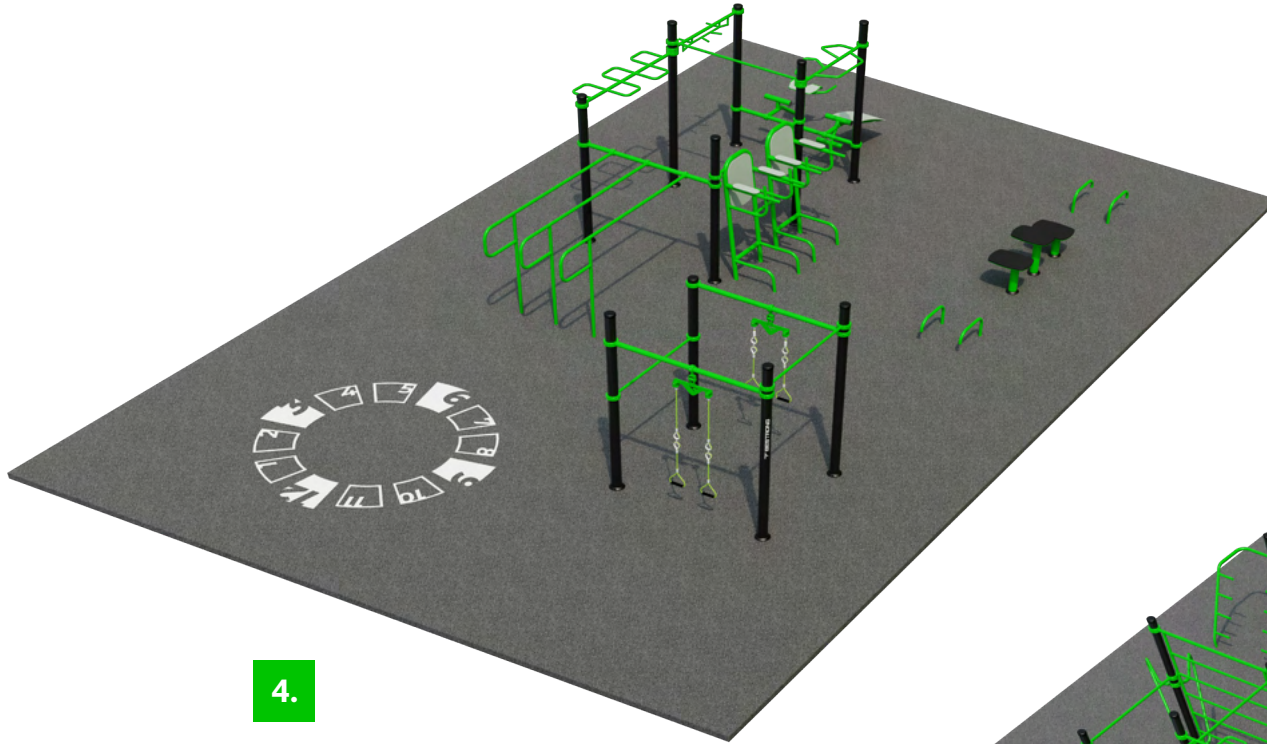

4.

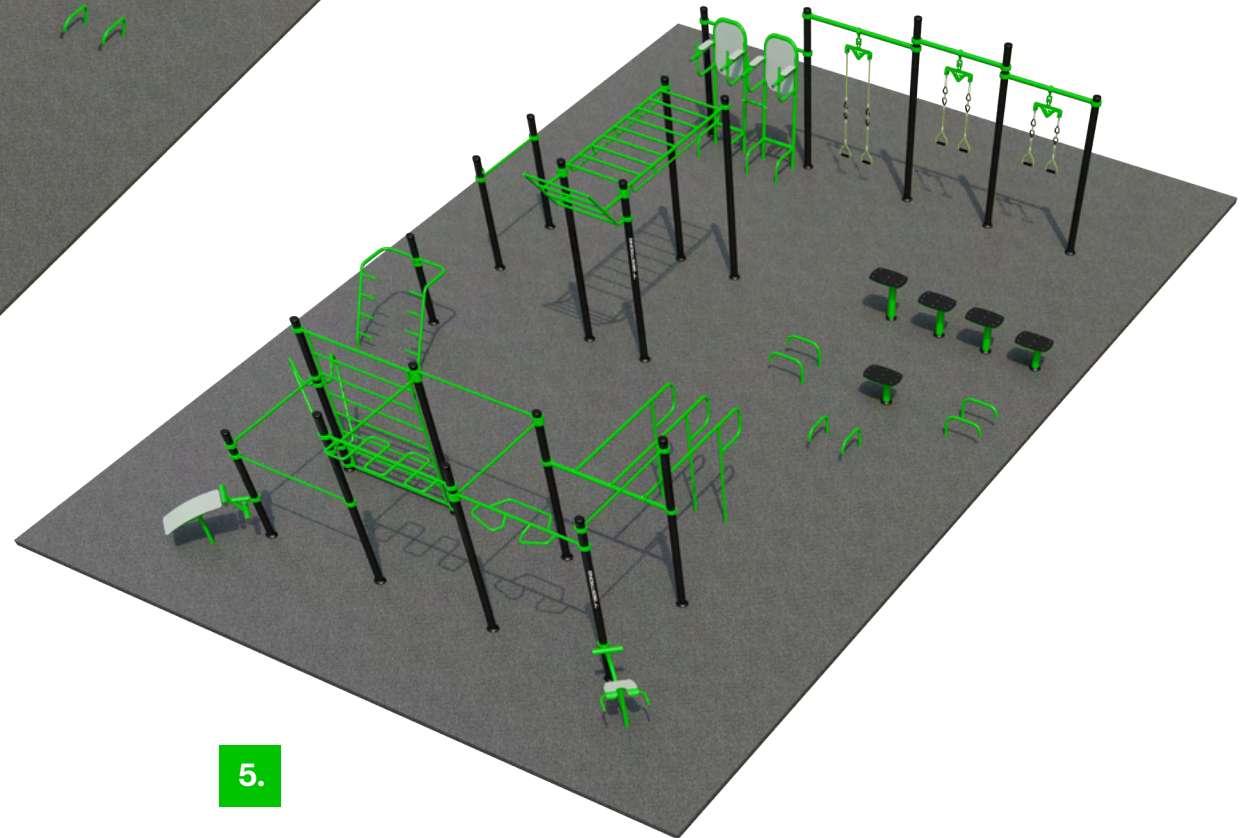

5.

| | ID. | Product Name | Certificate | Age Group | Capacity | Total Area | Number of equipment | Fall height | Net weight |
|----|---------|--------------|----------------------|------------|-----------|-------------------------------------|---------------------|-------------|------------|
| 4. | 1-3-245 | FitCampus 4 | EN 16630, ASTM F3101 | 14 + years | 32 people | 1355.8 ft' (45'-11,18" x 29'-6,33") | 16 | 4.92 ft | 1880 lbs |
| 5. | 1-3-249 | FitCampus 5 | EN 16630, ASTM F3101 | 14 + years | 46 people | 2189.7 ft' (60'-8,35" x 36'-1,07") | 23 | 4.92 ft | 3255 lbs |

FITLIVING

For the full range of FitLiving

- < click on the QR code, or
- < scan with your mobile device





We designed the BESTRONG FitLiving configuration to enhance the quality of life in residential complexes. Our fitness equipment, integrated into communal spaces, allows residents to conveniently embrace an active lifestyle. FitLiving parks offer an excellent solution for investors in residential projects, as they combine functionality, a unique lifestyle experience, and design, all with an attractive cost-to-value ratio and low maintenance requirements. The appearance and active use of our parks facilitate social interaction among residents, promoting the development of a harmonious and healthy community.

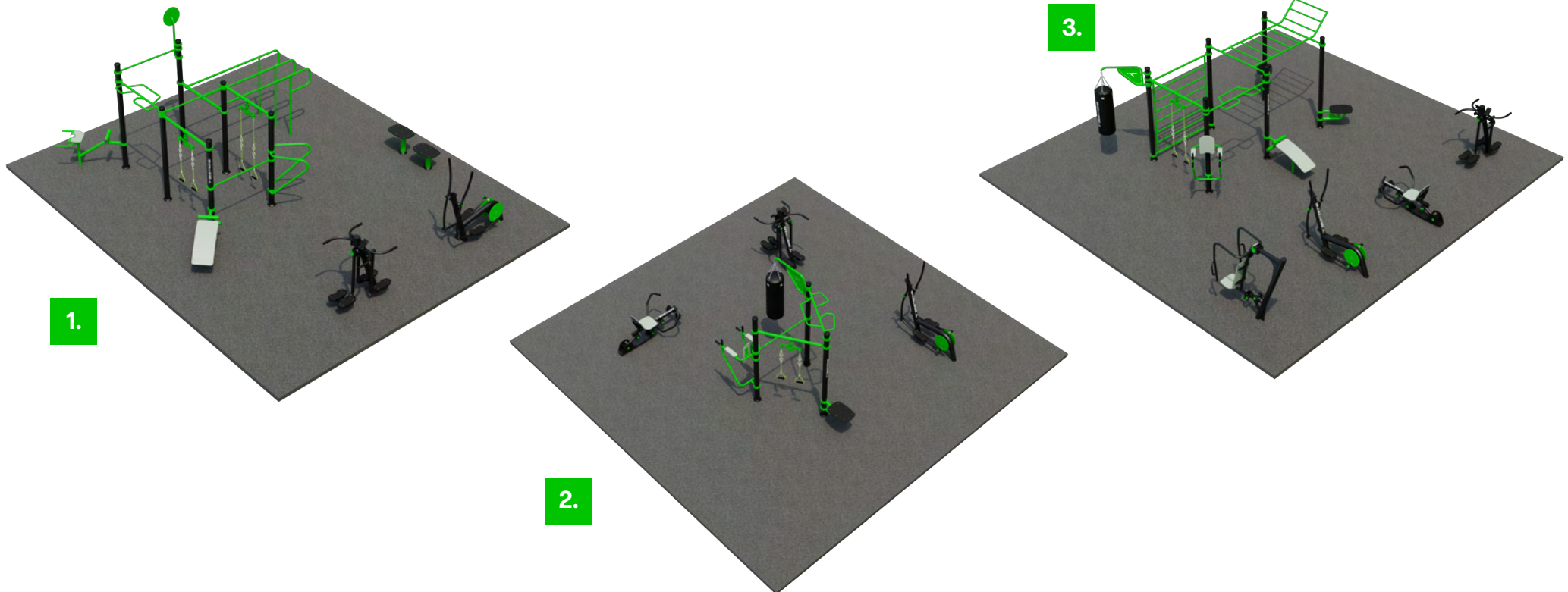

| | ID. | Product Name | Certificate | Age Group | Capacity | Total Area | Number of equipment | Fall height | Net weight |
|----|---------|--------------|----------------------|------------|-----------|------------------------------------------------|---------------------|--------------|------------|
| 1. | 1-3-232 | FitLiving 1 | EN 16630, ASTM F3101 | 14 + years | 34 people | 726.56 ft ² (24'-7.28" x 29'-6,33") | 17 | 4'-11.06" ft | 1520 lbs |
| 2. | 1-3-250 | FitLiving 2 | EN 16630, ASTM F3101 | 14 + years | 20 people | 871.6 ft ² (29'-6.33" x 29'-6,33") | 9 | 4.6 ft | 1622 lbs |
| 3. | 1-3-252 | FitLiving 3 | EN 16630, ASTM F3101 | 14 + years | 24 people | 1022.2 ft ² (32'-9.70" x 31'-2,02") | 12 | 4.6 ft | 1951 lbs |



4.



5.

| | ID. | Product Name | Certificate | Age Group | Capacity | Total Area | Number of equipment | Fall height | Net weight |
|----|---------|--------------|----------------------|------------|-----------|-------------------------------------------------|---------------------|-------------|------------|
| 4. | 1-3-251 | FitLiving 4 | EN 16630, ASTM F3101 | 14 + years | 28 people | 1022.2 ft ² (32'-9,70" x 31'-2,02") | 14 | 4.6 ft | 1725 lbs |
| 5. | 1-3-253 | FitLiving 5 | EN 16630, ASTM F3101 | 14 + years | 28 people | 1506.4 ft ² (45'-11,18" x 32'-9,70") | 14 | 6.9 ft | 2845 lbs |



6.

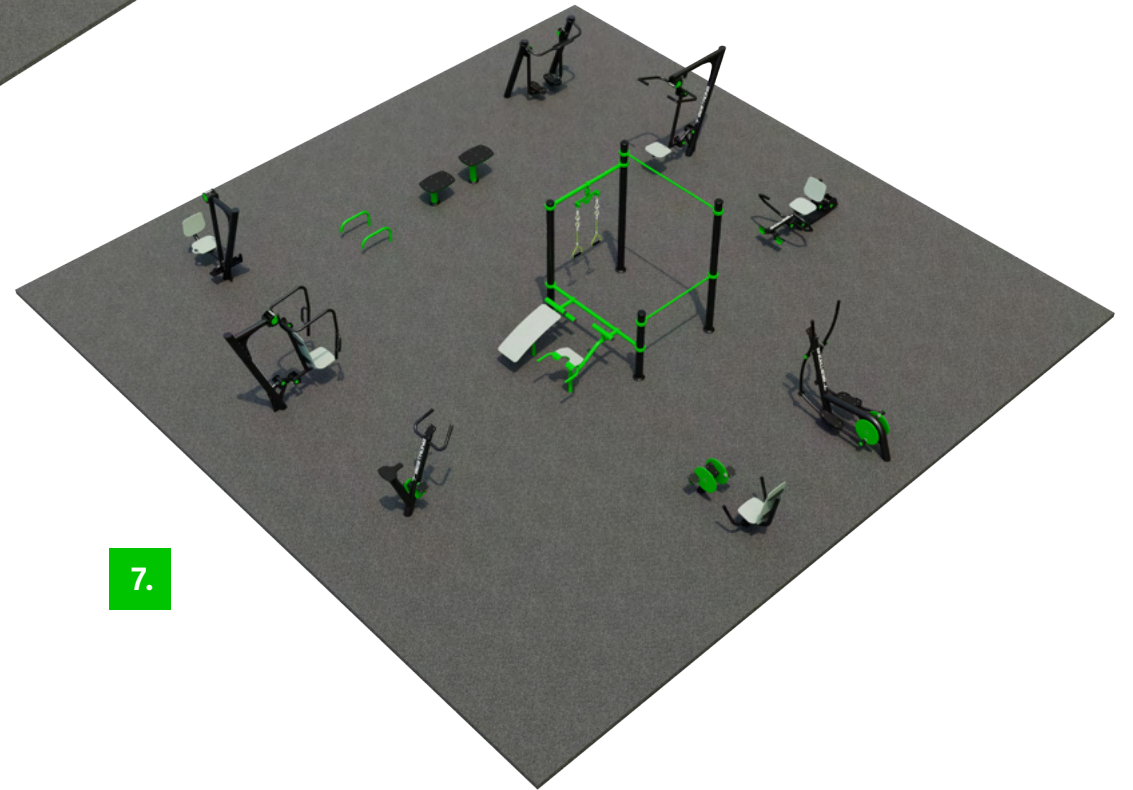

7.

| | ID. | Product Name | Certificate | Age Group | Capacity | Total Area | Number of equipment | Fall height | Net weight |
|----|---------|--------------|----------------------|------------|-----------|------------------------------------|---------------------|-------------|------------|
| 6. | 1-3-259 | FitLiving 6 | EN 16630, ASTM F3101 | 14 + years | 28 people | 1549.4 ft' (39'-4.44" x 39'-4,44") | 14 | 3.1 ft | 2250.5 lbs |
| 7. | 1-3-255 | FitLiving 7 | EN 16630, ASTM F3101 | 14 + years | 32 people | 1549.4 ft' (39'-4.44" x 39'-4,44") | 16 | 4.3 ft | 2587 lbs |

FITSOCIETY

For the full range of FitSociety

- < click on the QR code, or
- < scan with your mobile device





BESTRONG's FitSociety configuration features an impressive range of fitness equipment designed to revitalize public spaces and foster community engagement. Our experience has demonstrated that making sports accessible in public parks and other outdoor areas encourages active lifestyles. This configuration promotes comprehensive exercise, caters to various fitness levels and age groups, and fosters increased community interaction.

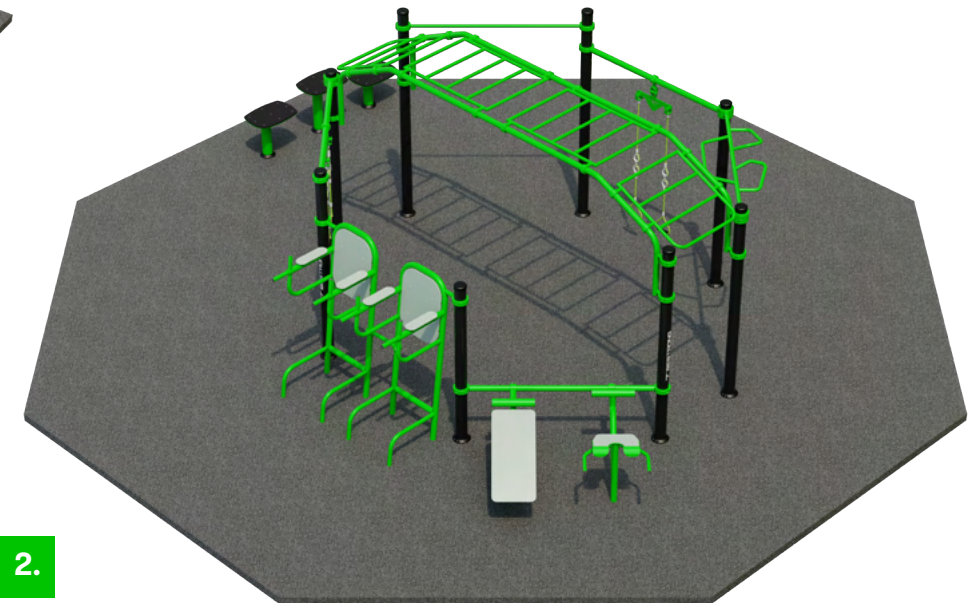
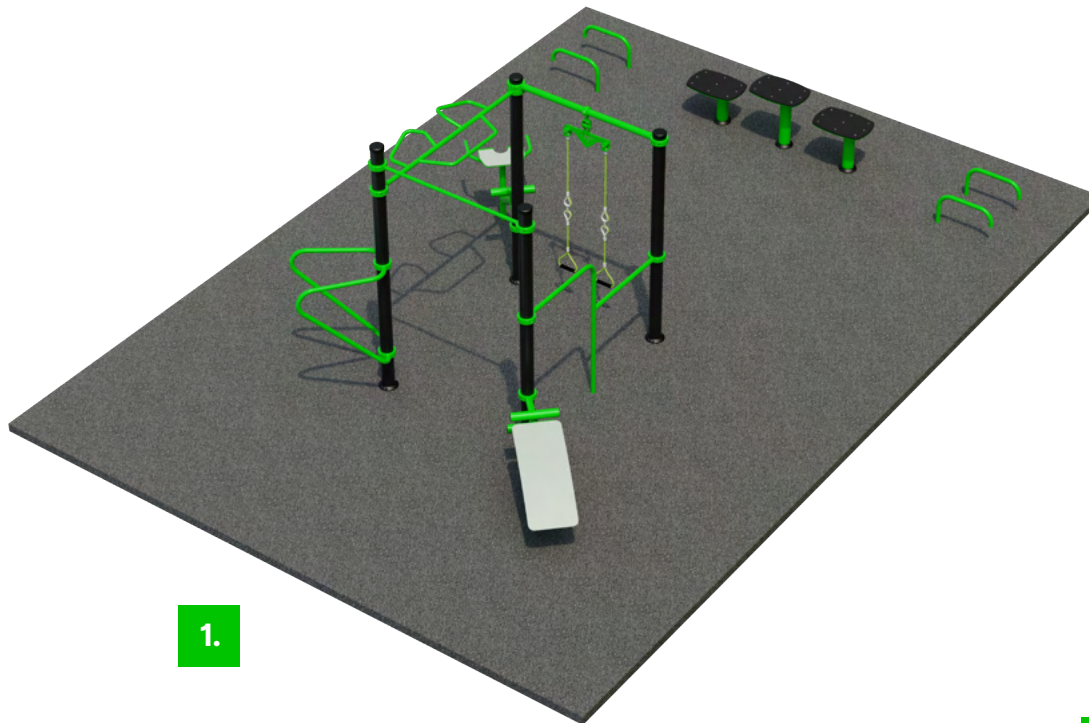

| | ID. | Product Name | Certificate | Age Group | Capacity | Total Area | Number of equipment | Fall height | Net weight |
|----|---------|--------------|----------------------|------------|-----------|-------------------------------------------------|---------------------|-------------|------------|
| 1. | 1-3-231 | FitSociety 1 | EN 16630, ASTM F3101 | 14 + years | 26 people | 548.96 ft ² (27'-10.65" x 19'-8.22") | 13 | 4.92 ft | 1023.5 lbs |
| 2. | 1-3-238 | FitSociety 2 | EN 16630, ASTM F3101 | 14 + years | 24 people | 753.5 ft ² (30'-1.02" x 30'-1.02") | 12 | 5'-2.99 ft | 1580 lbs |

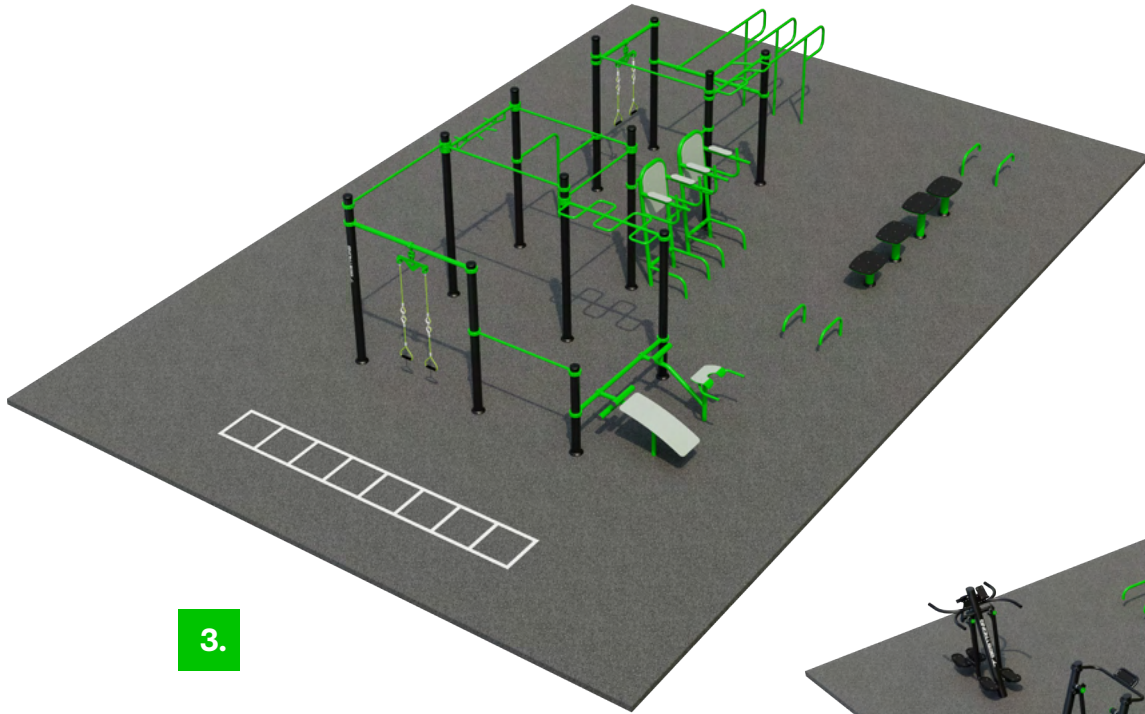

3.



4.

| | ID. | Product Name | Certificate | Age Group | Capacity | Total Area | Number of equipment | Fall height | Net weight |
|----|---------|--------------|----------------------|------------|-----------|-------------------------------------|---------------------|-------------|------------|
| 3. | 1-3-247 | FitSociety 3 | EN 16630, ASTM F3101 | 14 + years | 36 people | 1431.1 ft' (45'-11,18" x 31'-2,02") | 18 | 4.92 ft | 1907.5 lbs |
| 4. | 1-3-256 | FitSociety 4 | EN 16630, ASTM F3101 | 14 + years | 40 people | 1549.4 ft' (39'-4,44" x 39'-4,44") | 20 | 4.3 ft | 3173.5 lbs |

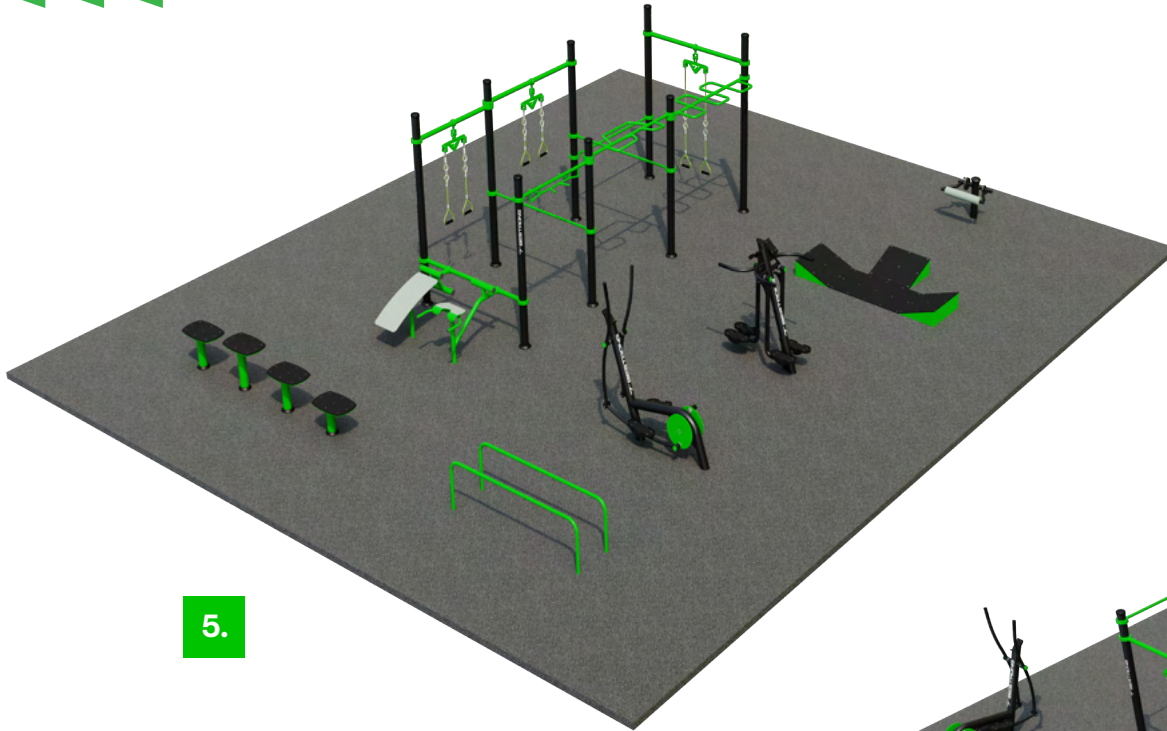

5.

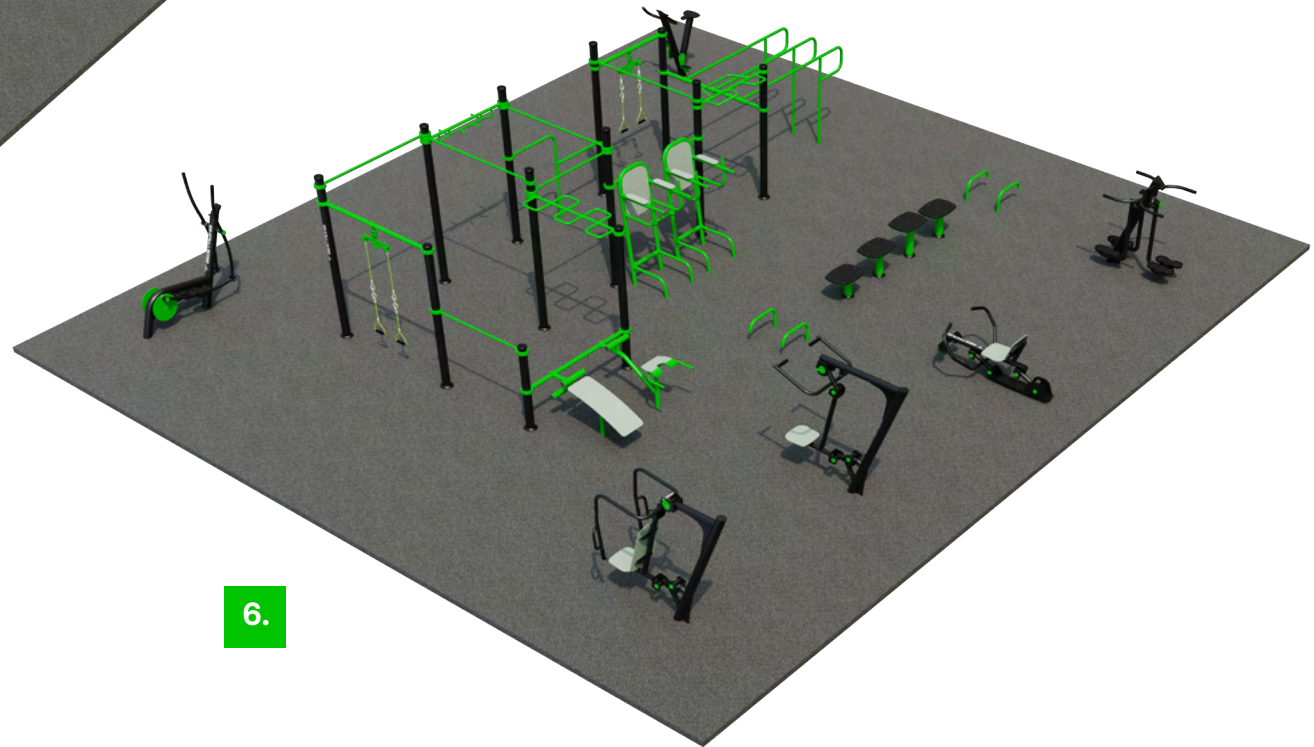

6.

| | ID. | Product Name | Certificate | Age Group | Capacity | Total Area | Number of equipment | Fall height | Net weight |
|----|---------|--------------|----------------------|------------|-----------|-------------------------------------------------|---------------------|-------------|------------|
| 5 | 1-3-260 | FitSociety 5 | EN 16630, ASTM F3101 | 14 + years | 32 people | 1597.9 ft ² (44'-3,50" x 36'-1,07") | 16 | 3.1 ft | 2546.5 lbs |
| 6. | 1-3-246 | FitSociety 6 | EN 16630, ASTM F3101 | 14 + years | 48 people | 1807.7 ft ² (45'-11,18" x 39'-4,44") | 24 | 4.92 ft | 3192.5 lbs |



7.

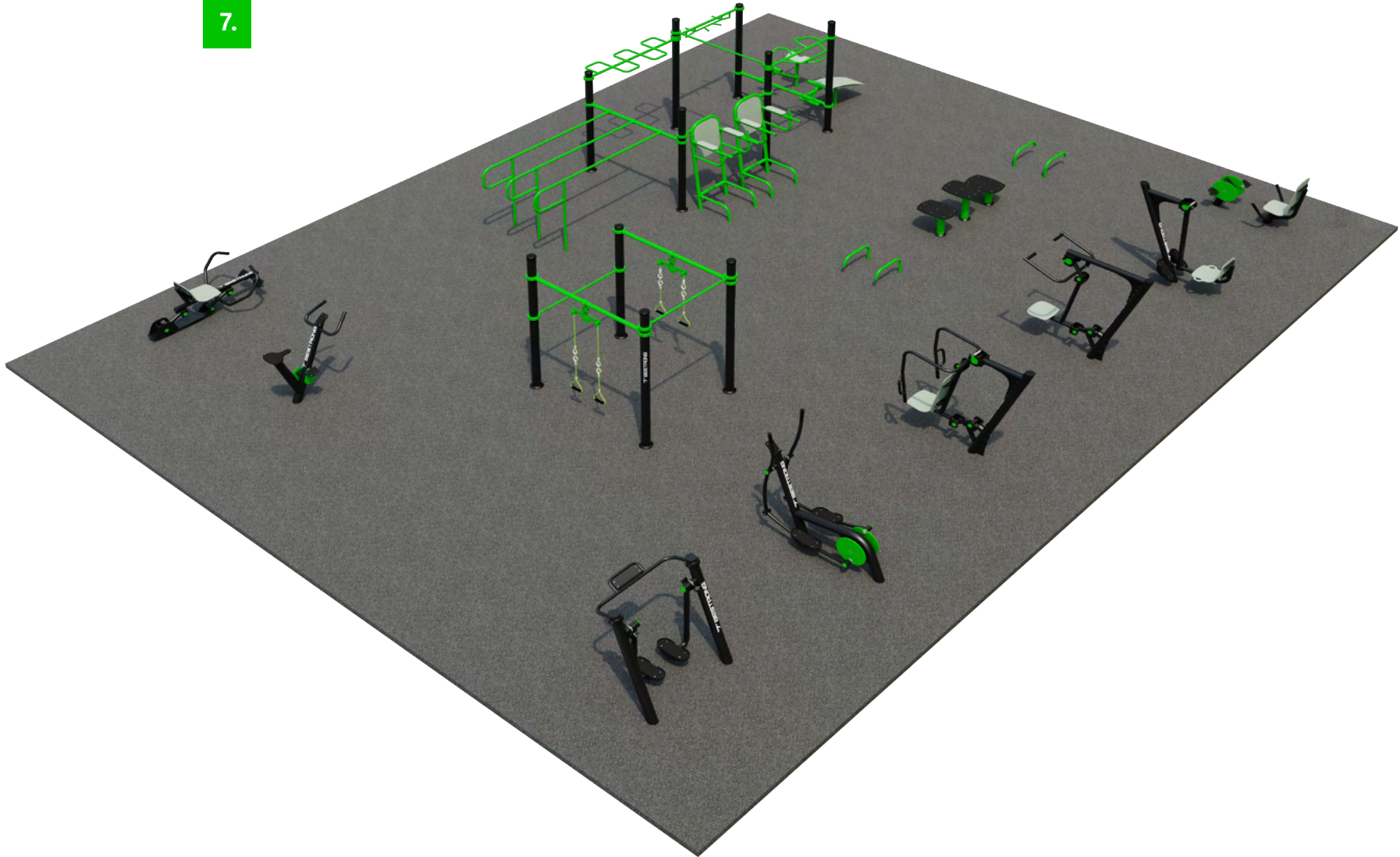

| ID. | Product Name | Certificate | Age Group | Capacity | Total Area | Number of equipment | Fall height | Net weight | |
|-----|--------------|--------------|----------------------|------------|------------|------------------------------------|-------------|------------|----------|
| 7. | 1-3-244 | FitSociety 7 | EN 16630, ASTM F3101 | 14 + years | 48 people | 1936.8 ft' (49'-2,55" x 39'-4,44") | 24 | 4.92 ft | 3711 lbs |



8.

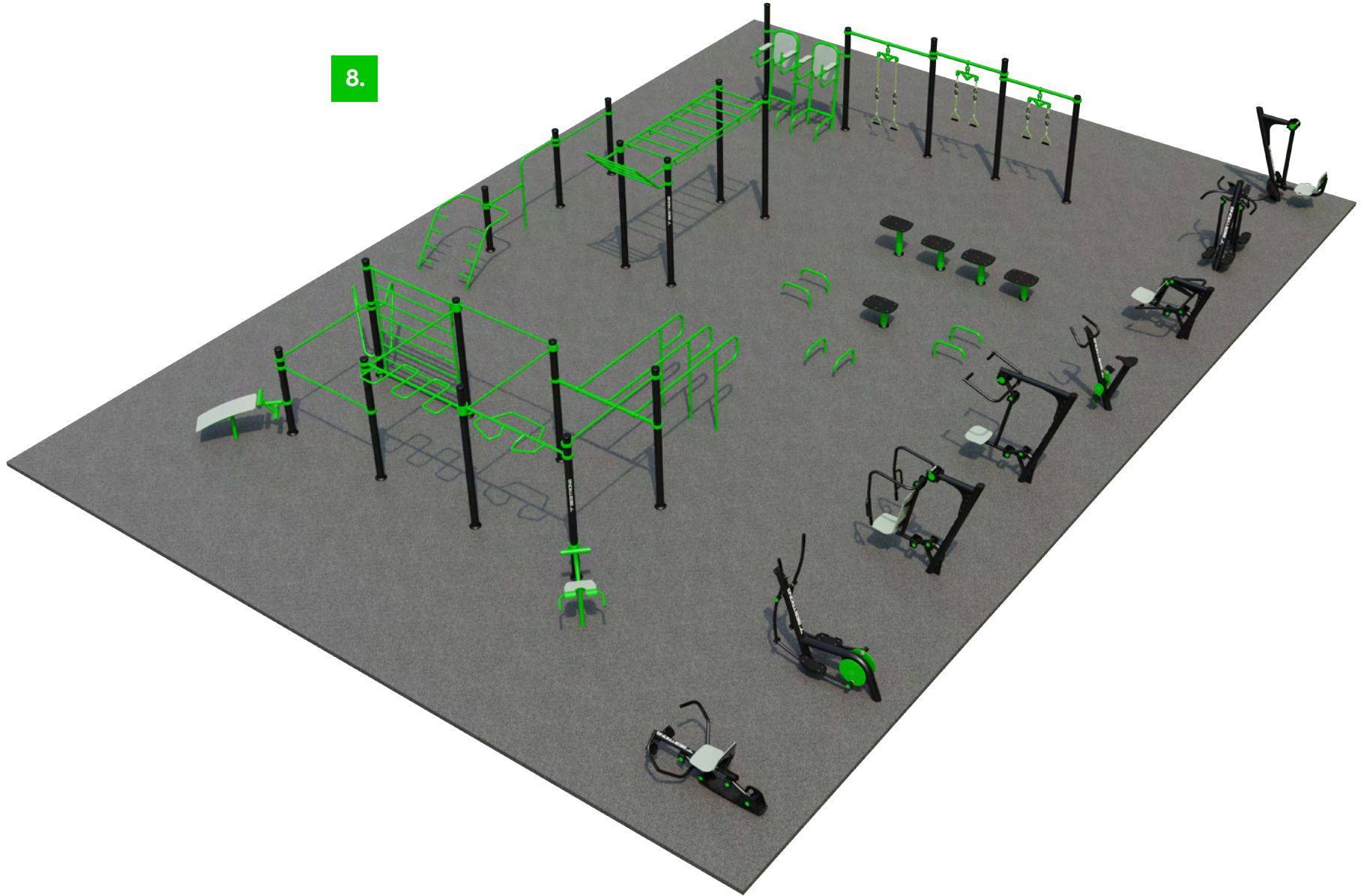

| ID. | Product Name | Certificate | Age Group | Capacity | Total Area | Number of equipment | Fall height | Net weight | |
|-----|--------------|--------------|----------------------|------------|------------|--------------------------------------|-------------|------------|------------|
| 8. | 1-3-248 | FitSociety 8 | EN 16630, ASTM F3101 | 14 + years | 62 people | 2937.5 ft' (63'-11,72" x 45'-11,18") | 31 | 6.9 ft | 3173.5 lbs |

FITSTAY

For the full range of FitStay

- < click on the QR code, or
- < scan with your mobile device





With our FitStay configuration, BESTRONG provides hotels and resorts with premium-quality outdoor fitness equipment. Beyond offering visually striking designs, we present a comprehensive solution for guests seeking exercise and mobility. FitStay enables you to broaden the wellness offerings of your hotels, significantly enhancing the overall guest experience.

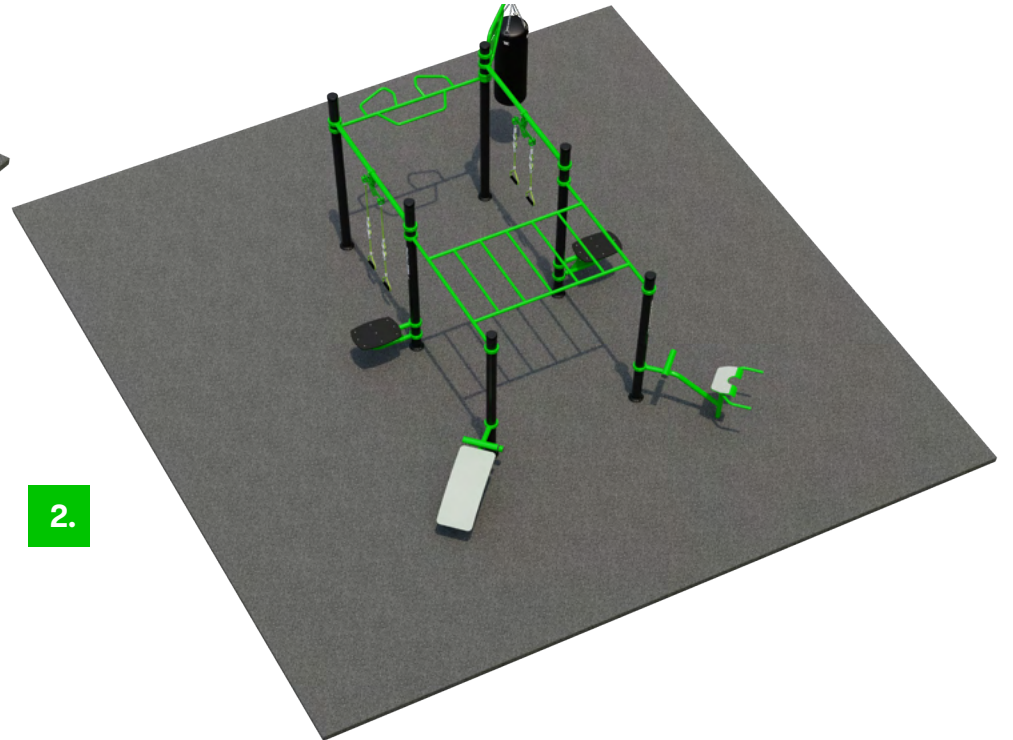
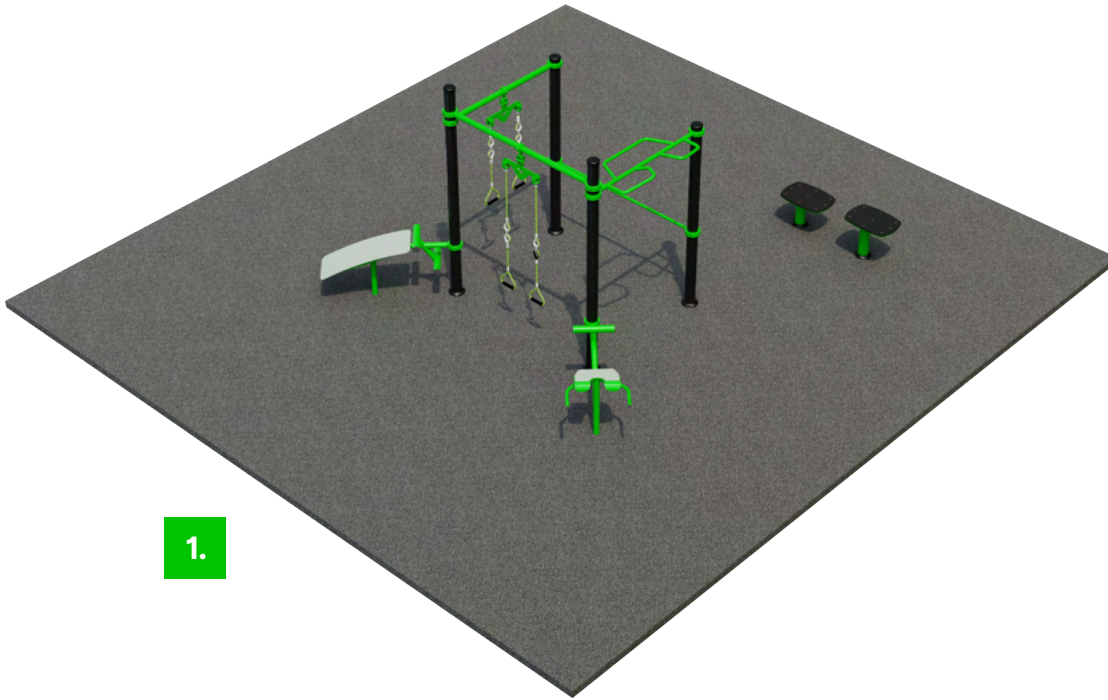

| | ID. | Product Name | Certificate | Age Group | Capacity | Total Area | Number of equipment | Fall height | Net weight |
|----|---------|--------------|----------------------|------------|-----------|------------------------------------------------|---------------------|-------------|------------|
| 1. | 1-3-257 | FitStay 1 | EN 16630, ASTM F3101 | 14 + years | 16 people | 731.7 ft ² (26'-2,96" x 27'-10,65") | 8 | 3.1 ft | 781.5 lbs |
| 2. | 1-3-258 | FitStay 2 | EN 16630, ASTM F3101 | 14 + years | 14 people | 823.1 ft ² (29'-6,33" x 27'-10,65") | 7 | 3.1 ft | 1467 lbs |

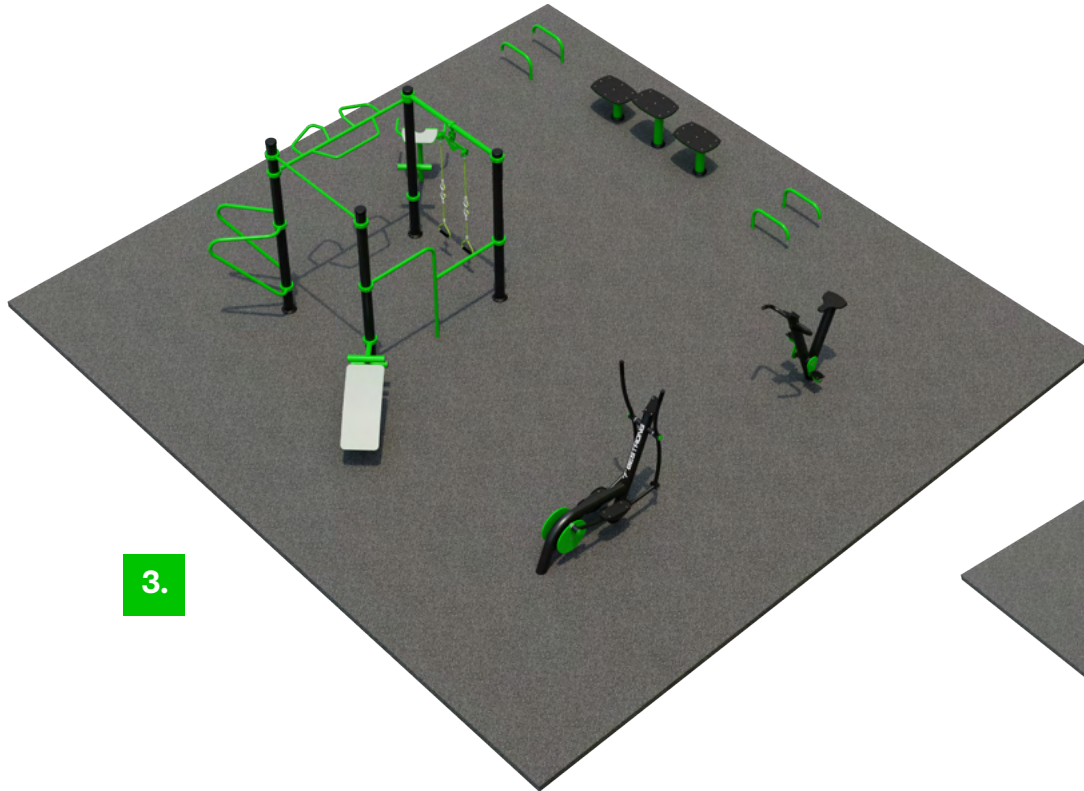

3.

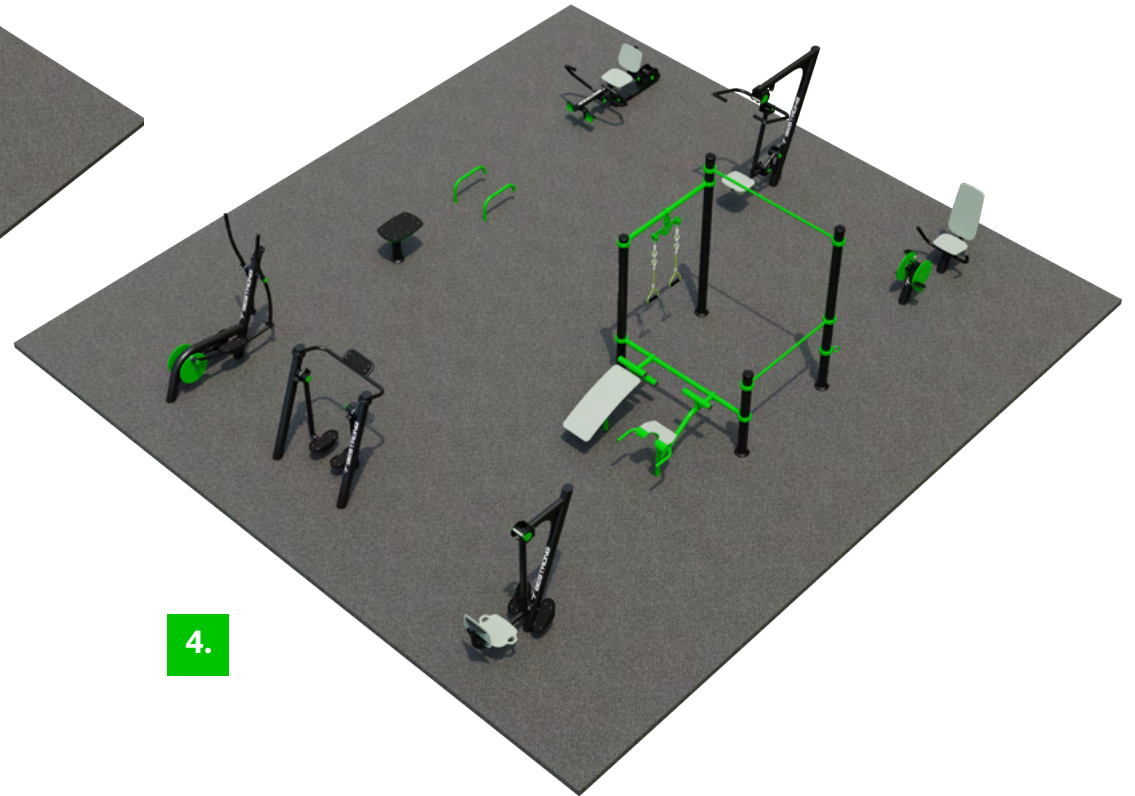

4.

| | ID. | Product Name | Certificate | Age Group | Capacity | Total Area | Number of equipment | Fall height | Net weight |
|----|---------|--------------|----------------------|------------|-----------|-------------------------------------------------|---------------------|-------------|------------|
| 3. | 1-3-230 | FitStay 3 | EN 16630, ASTM F3101 | 14 + years | 30 people | 823.44 ft ² (27'-10,65" x 29'-6,33") | 15 | 4.92 ft | 1033.5 lbs |
| 4. | 1-3-254 | FitStay 4 | EN 16630, ASTM F3101 | 14 + years | 28 people | 1022.2 ft ² (32'-9,70" x 31'-2,02") | 14 | 4.26 ft | 2080 lbs |

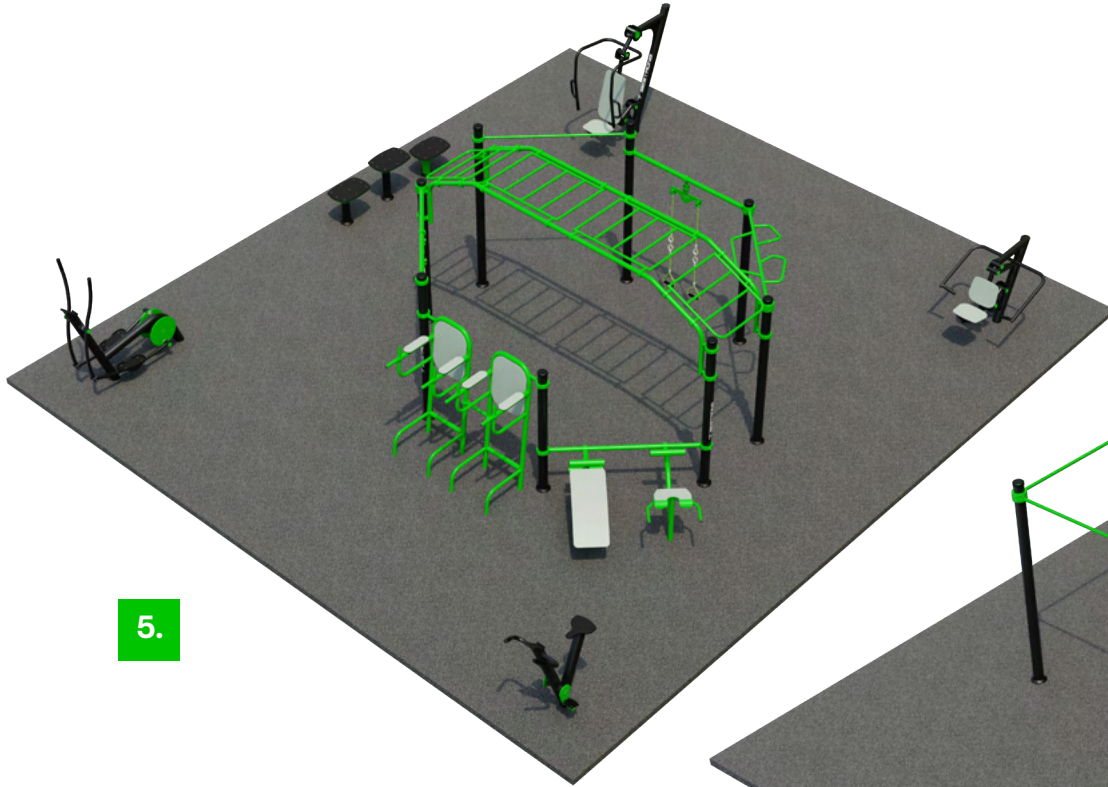

5.

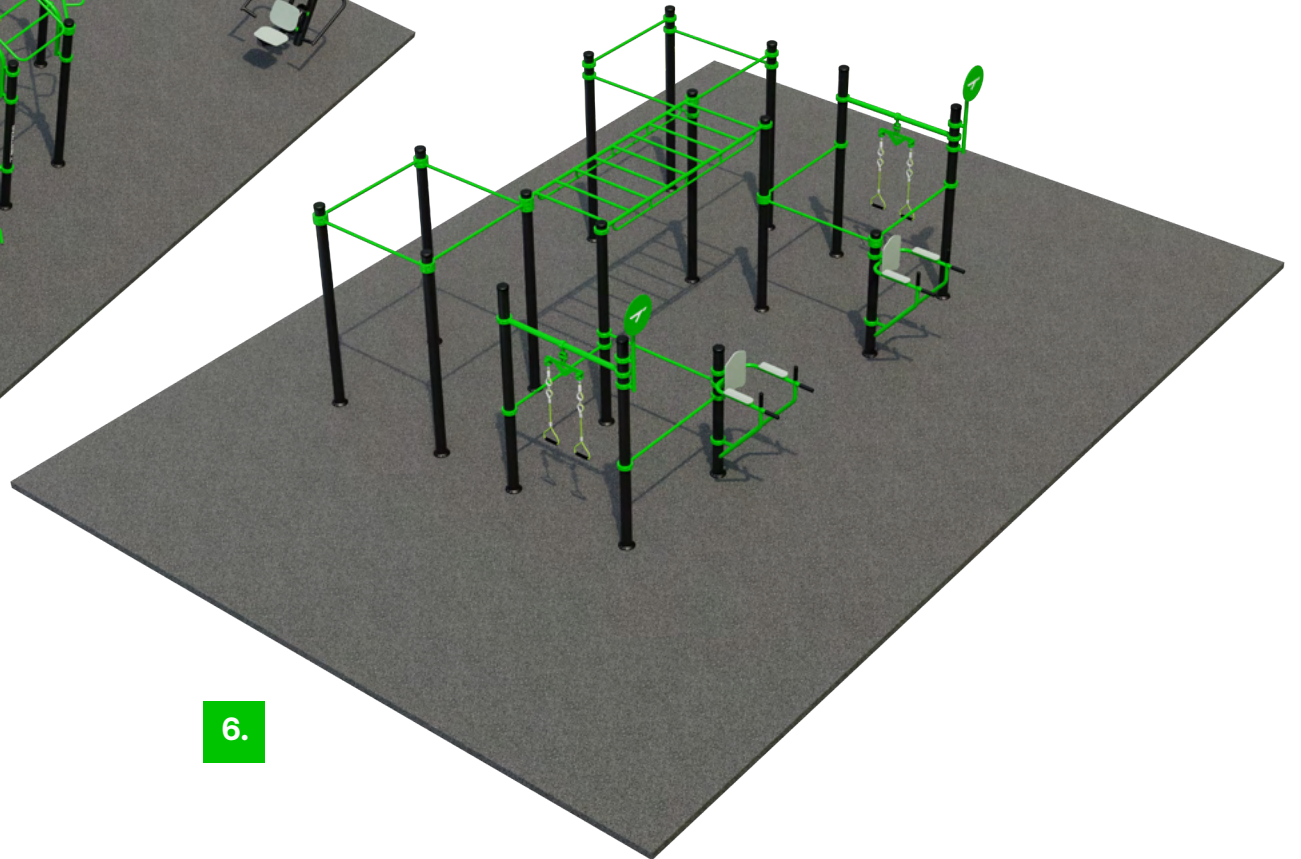

6.

| | ID. | Product Name | Certificate | Age Group | Capacity | Total Area | Number of equipment | Fall height | Net weight |
|----|---------|--------------|----------------------|------------|-----------|------------------------------------|---------------------|-------------|------------|
| 5. | 1-3-239 | FitStay 5 | EN 16630, ASTM F3101 | 14 + years | 28 people | 1936.8 ft' (49'-2,55" x 39'-4,44") | 14 | 5.25 ft | 2390 lbs |
| 6. | 1-3-240 | FitStay 6 | EN 16630, ASTM F3101 | 14 + years | 44 people | 1098 ft' (39'-4,44" x 27'-10,65") | 21 | 6.9 ft | 3173.5 lbs |

RECREATIONAL

For the full range of Recreational

- < click on the QR code, or
- < scan with your mobile device





Experience an exhilarating outdoor cardio workout with BESTRONG recreational cardio equipment! In designing our collection, our top priority was to provide an effective and enjoyable workout suitable for all age groups. These ergonomic products are especially advantageous for seniors, as they support the maintenance of fitness and mobility through low-impact exercises. The diversity and versatility of our outdoor cardio collection cater to all fitness levels and preferences, promoting and sustaining a healthy lifestyle.



| | ID. | Product Name | Certificate | Age Group | Capacity | Difficulty level | Concrete volume | Anchoring options | Critical fall height |
|----|---------|----------------------------|----------------------|------------|----------|------------------|-----------------|-------------------|----------------------|
| 1. | 1-3-300 | Elliptical Trainer | EN 16630, ASTM F3101 | 14 + years | 1 person | Easy | 40,61 ft³ | Surface mounted | 22.83" |
| 2. | 1-3-301 | Leg Abductor | EN 16630, ASTM F3101 | 14 + years | 1 person | Easy | 17,66 ft³ | Surface mounted | 31.5" |
| 3. | 1-3-302 | Hip Swing | EN 16630, ASTM F3101 | 14 + years | 1 person | Easy | 33,9 ft³ | Surface mounted | 31.5" |
| 4. | 1-1-303 | Leg Abductor And Hip Swing | EN 16630, ASTM F3101 | 14 + years | 2 people | Easy | 22,95 ft³ | Surface mounted | 31.5" |



| ID. | Product Name | Certificate | Age Group | Capacity | Difficulty level | Concrete volume | Anchoring options | Critical fall height |
|-----|---------------------|----------------------|------------|----------|------------------|-----------------|-------------------|----------------------|
| 5. | Air Walker | EN 16630, ASTM F3101 | 14 + years | 1 person | Easy | 42,38 ft³ | Surface mounted | 29.53" |
| 6. | Hand Bike | EN 16630, ASTM F3101 | 14 + years | 1 person | Easy | 17,66 ft³ | Surface mounted | - |
| 7. | Hand Bike With Seat | EN 16630, ASTM F3101 | 14 + years | 1 person | Easy | 40,61 ft³ | Surface mounted | 22.05" |
| 8. | Recumbent Bike | EN 16630, ASTM F3101 | 14 + years | 1 person | Easy | 42,38 ft³ | Surface mounted | 18.9" |
| 9. | Spinning Bike | EN 16630, ASTM F3101 | 14 + years | 1 person | Easy | 17,66 ft³ | Surface mounted | 43.31" |
| 10. | Leg Press | EN 16630, ASTM F3101 | 14 + years | 1 person | Medium | 17,66 ft³ | Surface mounted | 18.9" |
| 11. | Ski Walker | EN 16630, ASTM F3101 | 14 + years | 1 person | Easy | 40,61 ft³ | Surface mounted | 22.83" |
| 12. | Rower | EN 16630, ASTM F3101 | 14 + years | 1 person | Medium | 26,84 ft³ | Surface mounted | 35.43" |



| ID. | Product Name | Certificate | Age Group | Capacity | Difficulty level | Concrete volume | Anchoring options | Critical fall height |
|-----|--------------------|----------------------|------------|----------|------------------|-----------------|-------------------|----------------------|
| 13. | Tai Chi Wheel | EN 16630, ASTM F3101 | 14 + years | 2 people | Easy | 18.08 ft³ | Surface mounted | - |
| 14. | Lateral Pull-Down | EN 16630, ASTM F3101 | 14 + years | 1 person | Medium | 33,9 ft³ | Surface mounted | 31.5" |
| 15. | Mechanical Stepper | EN 16630, ASTM F3101 | 14 + years | 1 person | Easy | 33.9 ft³ | Surface mounted | 2' – 3.55" |
| 16. | Chest Press | EN 16630, ASTM F3101 | 14 + years | 1 person | Medium | 33,9 ft³ | Surface mounted | 31.5" |
| 17. | Twister | EN 16630, ASTM F3101 | 14 + years | 1 person | Easy | 23.73 ft³ | Surface mounted | 1' – 3.74" |
| 18. | Biceps Trainer | EN 16630, ASTM F3101 | 14 + years | 1 person | Easy | 17,65 ft³ | Surface mounted | 2'-1.58" |
| 19. | Leg Curl | EN 16630, ASTM F3101 | 14 + years | 1 person | Easy | 17,66 ft³ | Surface mounted | 18.9" |

CALISTHENICS

For the full range of Calisthenics

< click on the QR code, or
< scan with your mobile device



Elevate your outdoor training with BESTRONG's innovative calisthenics equipment! Meticulously designed by our team of qualified engineers and renowned athlete advisors. Using this collection will enhance your weight training experience. We offer a wide range of shapes and sizes to accommodate individuals of all skill levels, from beginners to professionals. Our calisthenics equipment embodies the perfect blend of durability, aesthetic appeal, and functional efficiency, providing a versatile platform for configuring any fitness park.

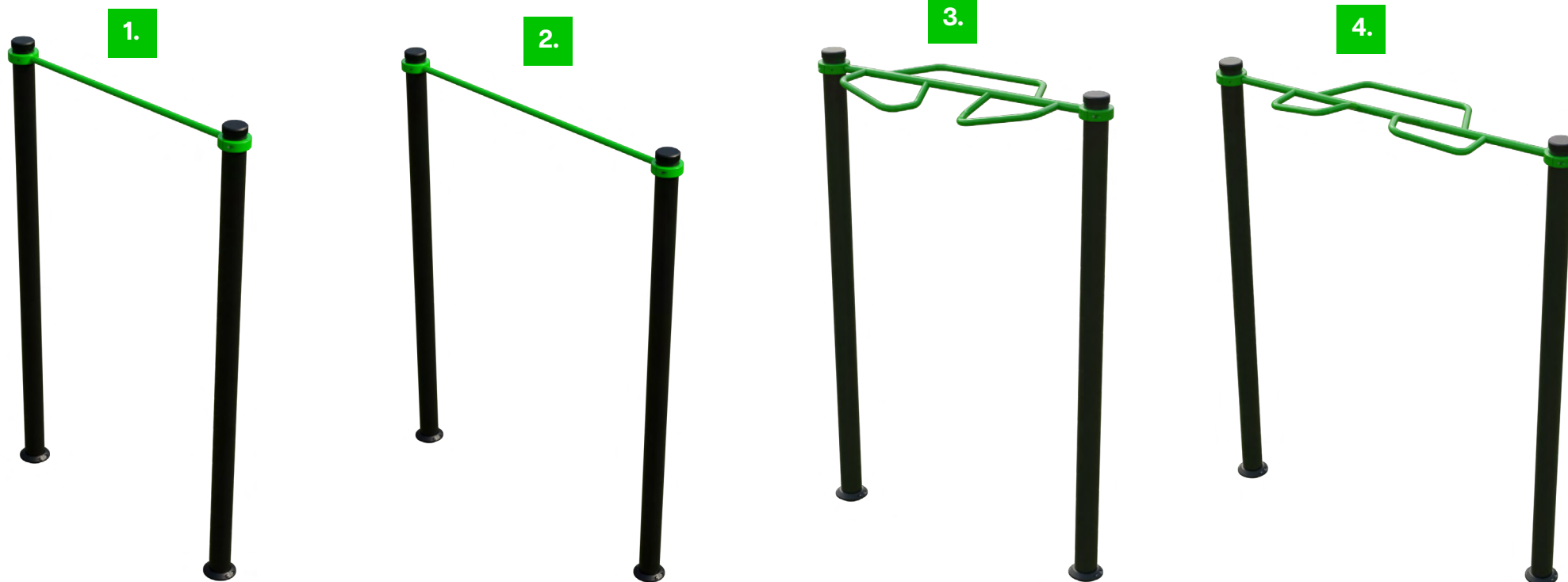

| ID. | Product Name | Certificate | Age Group | Capacity | Difficulty level | Concrete volume | Anchoring options | Critical fall height | |
|-----|--------------|---------------------------|----------------------|------------|------------------|-----------------|-------------------|----------------------|--------|
| 1. | 1-1-015 | Straight Pull-Up Bar 1500 | EN 16630, ASTM F3101 | 14 + years | 1 person | Hard | 14,13 ft' | In-ground or surface | 55.12" |
| 2. | 1-1-016 | Straight Pull-Up Bar 1900 | EN 16630, ASTM F3101 | 14 + years | 1 person | Hard | 14,13 ft' | In-ground or surface | 55.12" |
| 3. | 1-1-033 | Combined Pull-Up Bar 1500 | EN 16630, ASTM F3101 | 14 + years | 1 person | Hard | 14,13 ft' | In-ground or surface | 43.31" |
| 4. | 1-1-034 | Combined Pull-Up Bar 1900 | EN 16630, ASTM F3101 | 14 + years | 1 person | Hard | 14,13 ft' | In-ground or surface | 43.31" |



| ID. | Product Name | Certificate | Age Group | Capacity | Difficulty level | Concrete volume | Anchoring options | Critical fall height | |
|-----|--------------|----------------------------------|----------------------|------------|------------------|-----------------|-------------------|----------------------|--------|
| 5. | 1-1-037 | Multifunctional Pull-Up Bar 1500 | EN 16630, ASTM F3101 | 14 + years | 1 person | Hard | 14,13 ft³ | In-ground or surface | 47.24" |
| 6. | 1-1-036 | Multifunctional Pull-Up Bar 1900 | EN 16630, ASTM F3101 | 14 + years | 1 person | Hard | 14,13 ft³ | In-ground or surface | 47.24" |
| 7. | 1-1-047 | Narrow Pull-Up Bar 1500 | EN 16630, ASTM F3101 | 14 + years | 1 person | Hard | 14,13 ft³ | In-ground or surface | 43.31" |
| 8. | 1-1-048 | Narrow Pull-Up Bar 1900 | EN 16630, ASTM F3101 | 14 + years | 1 person | Hard | 14,13 ft³ | In-ground or surface | 43.31" |
| 9. | 1-1-032 | Horizontal Wave 1500 | EN 16630, ASTM F3101 | 14 + years | 1 person | Hard | 14,13 ft³ | In-ground or surface | 43.31" |
| 10. | 1-1-031 | Horizontal Wave 1900 | EN 16630, ASTM F3101 | 14 + years | 1 person | Hard | 14,13 ft³ | In-ground or surface | 43.31" |
| 11. | 1-1-028 | Wall Bars 1500 | EN 16630, ASTM F3101 | 14 + years | 1 person | Hard | 14,13 ft³ | In-ground or surface | 81.69" |
| 12. | 1-1-027 | Wall Bars 1900 | EN 16630, ASTM F3101 | 14 + years | 1 person | Hard | 14,13 ft³ | In-ground or surface | 81.69" |

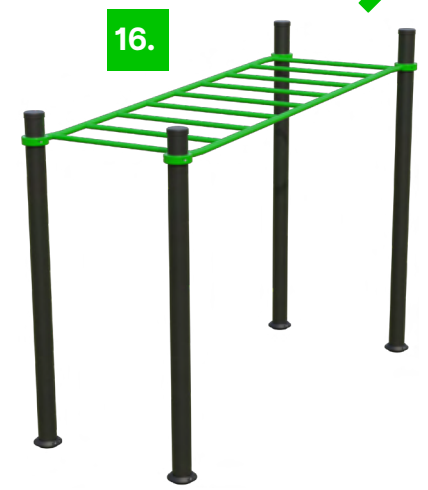

| ID. | Product Name | Certificate | Age Group | Capacity | Difficulty level | Concrete volume | Anchoring options | Critical fall height | |
|-----|--------------|-----------------------|----------------------|------------|------------------|-----------------|-----------------------|----------------------|-----------|
| 13. | 1-1-065 | Combined Ladder | EN 16630, ASTM F3101 | 14 + years | 2 people | Hard | 28,25 ft ³ | In-ground or surface | 5'-10.85" |
| 14. | 1-1-046 | Street Workout Ladder | EN 16630, ASTM F3101 | 14 + years | 2 people | Hard | 28,25 ft ³ | In-ground or surface | 47.24" |
| 15. | 1-1-029 | Horizontal Ladder | EN 16630, ASTM F3101 | 14 + years | 2 people | Hard | 28,25 ft ³ | In-ground or surface | 54.13" |
| 16. | 1-1-058 | Rising Ladder | EN 16630, ASTM F3101 | 14 + years | 2 people | Hard | 28,25 ft ³ | In-ground or surface | 47.24" |
| 17. | 1-1-045 | Trapeze Ladder | EN 16630, ASTM F3101 | 14 + years | 2 people | Hard | 28,25 ft ³ | In-ground or surface | 62.99" |
| 18. | 1-1-035 | Maximum Ladder | EN 16630, ASTM F3101 | 14 + years | 2 people | Hard | 28,25 ft ³ | In-ground or surface | 63.78" |
| 19. | 1-1-049 | Monkey Rack | EN 16630, ASTM F3101 | 14 + years | 1 person | Hard | 14,13 ft ³ | In-ground or surface | 64.96" |
| 20. | 1-1-030 | Low Pull-Up & Dip Bar | EN 16630, ASTM F3101 | 14 + years | 2 people | Easy | 21,19 ft ³ | In-ground or surface | 55.12" |

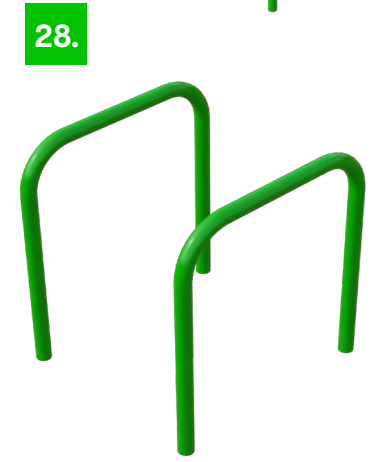
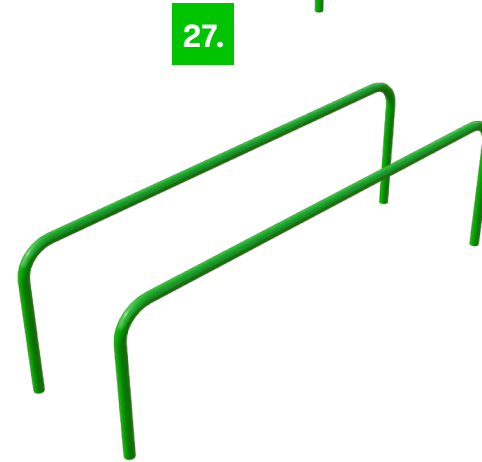
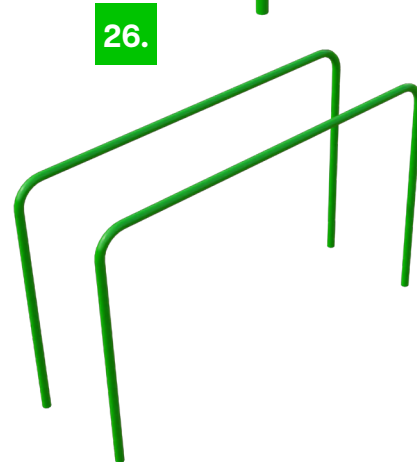
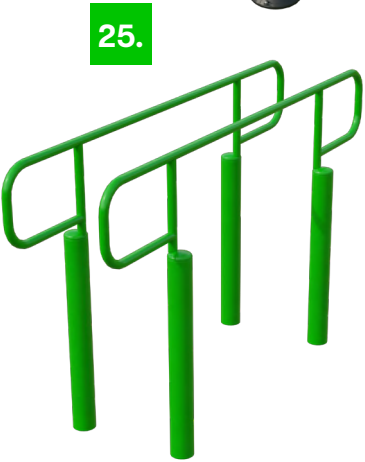
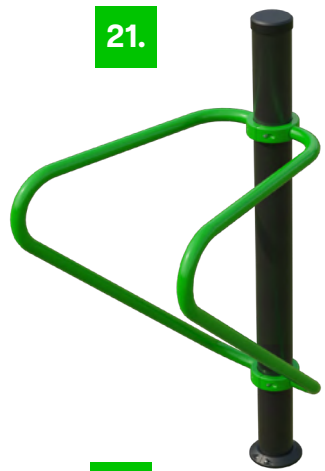

| ID. | Product Name | Certificate | Age Group | Capacity | Difficulty level | Concrete volume | Anchoring options | Critical fall height |
|-----|---------------------------------|----------------------|------------|----------|------------------|-----------------|----------------------|----------------------|
| 21. | Dip Bar | EN 16630, ASTM F3101 | 14 + years | 1 person | Medium | 7,06 ft³ | In-ground or surface | 54.13" |
| 22. | Z Dip Bar | EN 16630, ASTM F3101 | 14 + years | 1 person | Medium | 21,19 ft³ | In-ground or surface | 37.95" |
| 23. | Three Element Parallel Bar 1500 | EN 16630, ASTM F3101 | 14 + years | 2 people | Medium | 22,95 ft³ | In-ground or surface | 59.06" |
| 24. | Three Element Parallel Bar 1900 | EN 16630, ASTM F3101 | 14 + years | 2 people | Medium | 26,49 ft³ | In-ground or surface | 59.06" |
| 25. | Parallel Bars | EN 16630, ASTM F3101 | 14 + years | 2 people | Medium | 28,25 ft³ | In-ground or surface | 59.06" |
| 26. | Practicing Parallel Bars | EN 16630, ASTM F3101 | 14 + years | 2 people | Medium | 30,9 ft³ | In-ground or surface | 51.18" |
| 27. | Low Parallel Bars | EN 16630, ASTM F3101 | 14 + years | 2 people | Medium | 30,9 ft³ | In-ground or surface | 51.18" |
| 28. | Mini Parallel Bars | EN 16630, ASTM F3101 | 14 + years | 1 person | Medium | 18,54 ft³ | In-ground or surface | 23.62" |

CROSS-TRAINING

For the full range of Cross-Training

< click on the QR code, or
< scan with your mobile device



Embark on a journey toward enhanced functional fitness with BESTRONG's dynamic Cross-training tools! This collection is meticulously designed to target various muscle groups, enrich the workout experience, and boost endurance and flexibility. The sturdy design of our equipment ensures safety during use. The array of exercises that can be performed makes it an ideal choice for both beginners and advanced athletes. Enjoy an outdoor training experience that harnesses the power of tools to elevate your performance to new heights!

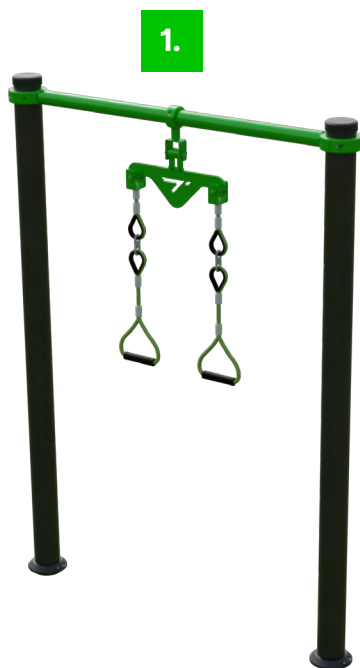

| | ID. | Product Name | Certificate | Age Group | Capacity | Difficulty level | Concrete volume | Anchoring options | Critical fall height |
|----|---------|------------------------------|----------------------|------------|----------|------------------|-----------------|----------------------|----------------------|
| 1. | 1-1-226 | Suspension Trainer 1500 600 | EN 16630, ASTM F3101 | 14 + years | 1 person | Easy | 14,13 ft³ | In-ground or surface | - |
| | 1-1-230 | Suspension Trainer 1900 600 | EN 16630, ASTM F3101 | 14 + years | 1 person | Easy | 14,13 ft³ | In-ground or surface | - |
| 2. | 1-1-227 | Suspension Trainer 1500 930 | EN 16630, ASTM F3101 | 14 + years | 1 person | Easy | 14,13 ft³ | In-ground or surface | - |
| | 1-1-229 | Suspension Trainer 1900 930 | EN 16630, ASTM F3101 | 14 + years | 1 person | Easy | 14,13 ft³ | In-ground or surface | - |
| 3. | 1-1-125 | Suspension Trainer 1500 1430 | EN 16630, ASTM F3101 | 14 + years | 1 person | Easy | 14,13 ft³ | In-ground or surface | - |
| | 1-1-228 | Suspension Trainer 1900 1430 | EN 16630, ASTM F3101 | 14 + years | 1 person | Easy | 14,13 ft³ | In-ground or surface | - |



4.



5.



6.



7.



| | ID. | Product Name | Certificate | Age Group | Capacity | Difficulty level | Concrete volume | Anchoring options | Critical fall height |
|----|---------|----------------------|----------------------|------------|----------|------------------|-----------------|----------------------|----------------------|
| 4. | 1-1-061 | Rope Holder | EN 16630, ASTM F3101 | 14 + years | 1 person | Easy | 7,06 ft³ | In-ground or surface | - |
| 5. | 1-1-054 | Boxing Bag Holder | EN 16630, ASTM F3101 | 14 + years | 1 person | Easy | 7,06 ft³ | In-ground or surface | - |
| 6. | 1-1-020 | Climbing Rope Frame | EN 16630, ASTM F3101 | 14 + years | 1 person | Medium | 14,13 ft³ | In-ground or surface | 125.98" |
| 7. | 1-1-055 | Medicine Ball Target | EN 16630, ASTM F3101 | 14 + years | 1 person | Easy | 7,06 ft³ | In-ground or surface | - |

FITNESS

For the full range of Fitness

- < click on the QR code, or
- < scan with your mobile device



Unlock the advantages of comprehensive outdoor training with BESTRONG's general fitness equipment! By utilizing a combination of our equipment, co-designed by our team of professional fitness experts and engineers, you can craft a fitness regimen that targets all major muscle groups. Whether your focus is on strengthening core muscles, sculpting muscle tone, or improving flexibility, our equipment will support your fitness objectives. Explore a new dimension of outdoor fitness with our collection, which intensifies your workouts while ensuring safety, and allows you to customize your fitness equipment to meet your specific needs.

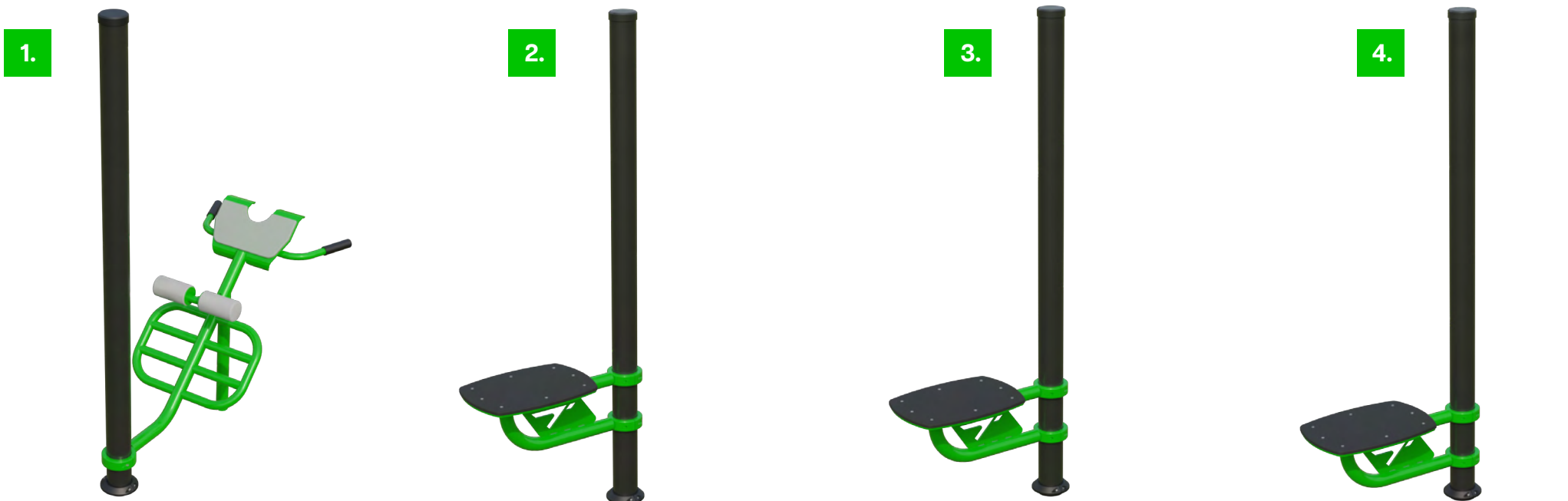

| ID. | Product Name | Certificate | Age Group | Capacity | Difficulty level | Concrete volume | Anchoring options | Critical fall height | |
|-----|--------------|-----------------------|----------------------|------------|------------------|-----------------|-------------------|----------------------|------------|
| 1. | 1-1-167 | Hyperbending Bench | EN 16630, ASTM F3101 | 14 + years | 1 person | Medium | 7,06 ft' | In-ground or surface | 3' – 3.36" |
| 2. | 1-1-129 | Stepper on Pillar 400 | EN 16630, ASTM F3101 | 14 + years | 1 person | Easy | 7,06 ft' | In-ground or surface | 15.75" |
| 3. | 1-1-129 | Stepper on Pillar 500 | EN 16630, ASTM F3101 | 14 + years | 1 person | Easy | 7,06 ft' | In-ground or surface | 19.69" |
| 4. | 1-1-129 | Stepper on Pillar 600 | EN 16630, ASTM F3101 | 14 + years | 1 person | Easy | 7,06 ft' | In-ground or surface | 23.62" |

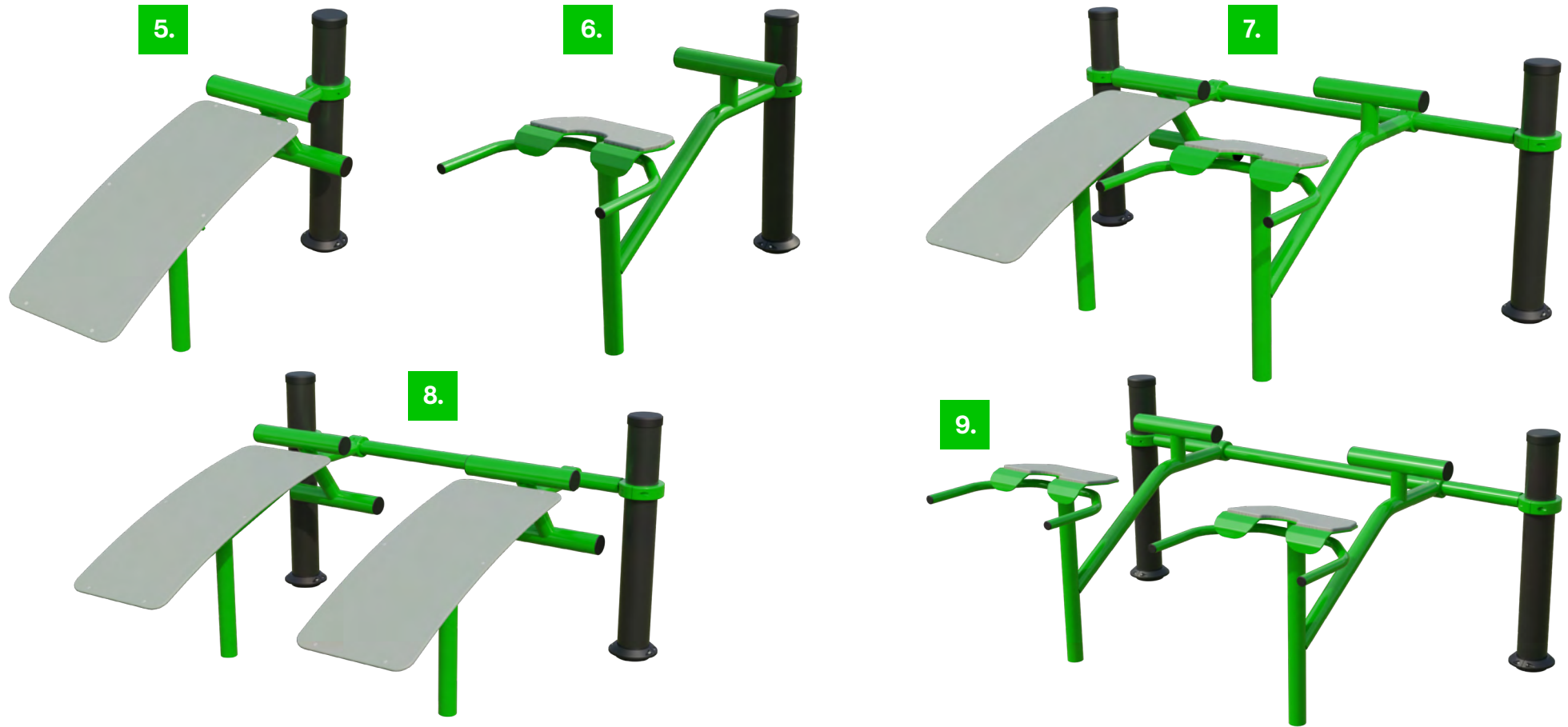

| | ID. | Product Name | Certificate | Age Group | Capacity | Difficulty level | Concrete volume | Anchoring options | Critical fall height |
|----|---------|---------------------------------|----------------------|------------|----------|------------------|-----------------|----------------------|----------------------|
| 5. | 1-1-053 | Ab Trainer | EN 16630, ASTM F3101 | 14 + years | 1 person | Easy | 14,13 ft³ | In-ground or surface | 22.83" |
| 6. | 1-1-050 | Back Trainer | EN 16630, ASTM F3101 | 14 + years | 1 person | Easy | 14,13 ft³ | In-ground or surface | 28.54" |
| 7. | 1-1-041 | Ab & Back Trainer 1500 | EN 16630, ASTM F3101 | 14 + years | 2 people | Easy | 28,25 ft³ | In-ground or surface | 31.5" |
| | 1-1-040 | Ab & Back Trainer 1900 | EN 16630, ASTM F3101 | 14 + years | 2 people | Easy | 28,25 ft³ | In-ground or surface | 31.5" |
| 8. | 1-1-039 | Double Ab Training Bench 1500 | EN 16630, ASTM F3101 | 14 + years | 2 people | Easy | 28,25 ft³ | In-ground or surface | 27.56" |
| | 1-1-038 | Double Ab Training Bench 1900 | EN 16630, ASTM F3101 | 14 + years | 2 people | Easy | 28,25 ft³ | In-ground or surface | 27.56" |
| 9. | 1-1-023 | Double Back Training Bench 1500 | EN 16630, ASTM F3101 | 14 + years | 2 people | Easy | 28,25 ft³ | In-ground or surface | 34.65" |
| | 1-1-026 | Double Back Training Bench 1900 | EN 16630, ASTM F3101 | 14 + years | 2 people | Easy | 28,25 ft³ | In-ground or surface | 34.65" |

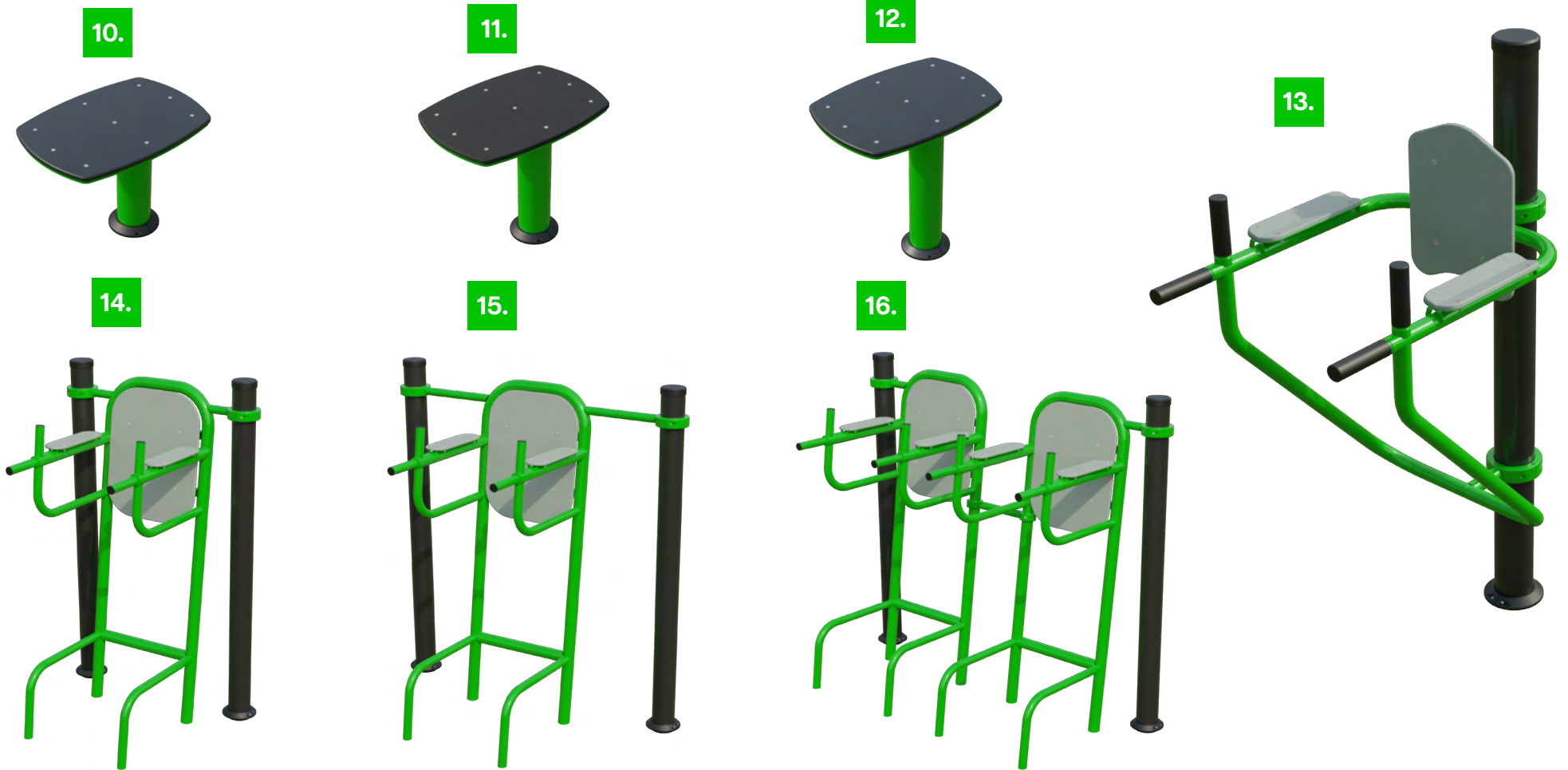

| ID. | Product Name | Certificate | Age Group | Capacity | Difficulty level | Concrete volume | Anchoring options | Critical fall height |
|-----|-----------------------------------|----------------------|------------|----------|------------------|-----------------------|----------------------|----------------------|
| 10. | Stepper 400 | EN 16630, ASTM F3101 | 14 + years | 1 person | Easy | 18,08 ft ³ | In-ground or surface | 19.09" |
| 11. | Stepper 500 | EN 16630, ASTM F3101 | 14 + years | 1 person | Easy | 18,08 ft ³ | In-ground or surface | 23.03" |
| 12. | Stepper 600 | EN 16630, ASTM F3101 | 14 + years | 1 person | Easy | 18,08 ft ³ | In-ground or surface | 26.97" |
| 13. | Multifunctional Trainer On Pillar | EN 16630, ASTM F3101 | 14 + years | 1 person | Medium | 17,66 ft ³ | In-ground or surface | 54.33" |
| 14. | Multifunctional Trainer 950 | EN 16630, ASTM F3101 | 14 + years | 1 person | Medium | 27,55 ft ³ | In-ground or surface | 53.94" |
| 15. | Multifunctional Trainer 1500 | EN 16630, ASTM F3101 | 14 + years | 1 person | Medium | 37,08 ft ³ | In-ground or surface | 53.94" |
| 16. | Double Multifunctional Trainer | EN 16630, ASTM F3101 | 14 + years | 2 people | Medium | 45,91 ft ³ | In-ground or surface | 53.94" |

ACCESSIBLE EQUIPMENT



Our message at BeStrong USA is simple: sport is for everyone. From 2024 we are proud to offer accessible outdoor exercise equipment for everyone, including disabled individuals. In addition to strengthening different parts of the body, physical activity improves your mental health, overall fitness, and quality of life. Our innovative outdoor fitness equipment is designed to be accessible, safe, and easy to use.

1.

2.

3.



| | ID. | Product Name | Certificate | Age Group | Capacity | Difficulty level | Concrete volume | Anchoring options | Critical fall height |
|----|---------|-------------------|----------------------|------------|----------|------------------|-----------------|-------------------|----------------------|
| 1. | 1-1-331 | Shrug | EN 16630, ASTM F3101 | 14 + years | 1 person | Medium | 18.08 ft³ | Surface mounted | 18.5" |
| 2. | 1-1-332 | Lateral Pull-Down | EN 16630, ASTM F3101 | 14 + years | 1 person | Medium | 18.08 ft³ | Surface mounted | 18.5" |
| 3. | 1-1-020 | Chest Press | EN 16630, ASTM F3101 | 14 + years | 1 person | Medium | 18.08 ft³ | Surface mounted | 18.5" |

ADJUSTABLE WEIGHT



Elevate your outdoor workouts with our adjustable load outdoor collection! Offering versatility and resilience in the face of today's extreme weather conditions, this range is tailored for the contemporary fitness enthusiast. Whether your goal is to build muscle, tone, lose weight, or enhance endurance, the adjustable weight features enable you to customize the direction and intensity of your workout effortlessly. Our collection blends innovative design with robust construction, ensuring that you can experience the functionality and versatility of an indoor gym in the great outdoors, closer to nature. Join us as we redefine your outdoor exercise experience together!



| | ID. | Product Name | Certificate | Age Group | Capacity | Difficulty level | Concrete volume | Anchoring options | Critical fall height |
|----|---------|--------------|----------------------|------------|----------|------------------|-----------------------|-------------------|----------------------|
| 1. | 1-1-322 | Tricep Press | EN 16630, ASTM F3101 | 14 + years | 1 person | - | 14.12 ft ³ | Surface mounted | - |
| 2. | 1-1-323 | Squat | EN 16630, ASTM F3101 | 14 + years | 1 person | - | 21.19 ft ³ | Surface mounted | - |
| 3. | 1-1-325 | Leg Curl | EN 16630, ASTM F3101 | 14 + years | 1 person | - | 56.50 ft ³ | Surface mounted | 18.5" |



4.



5.

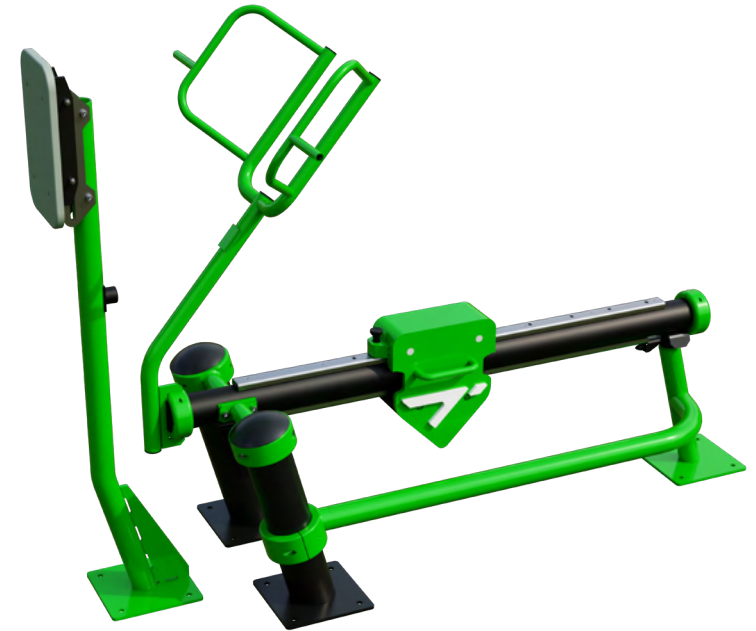

6.

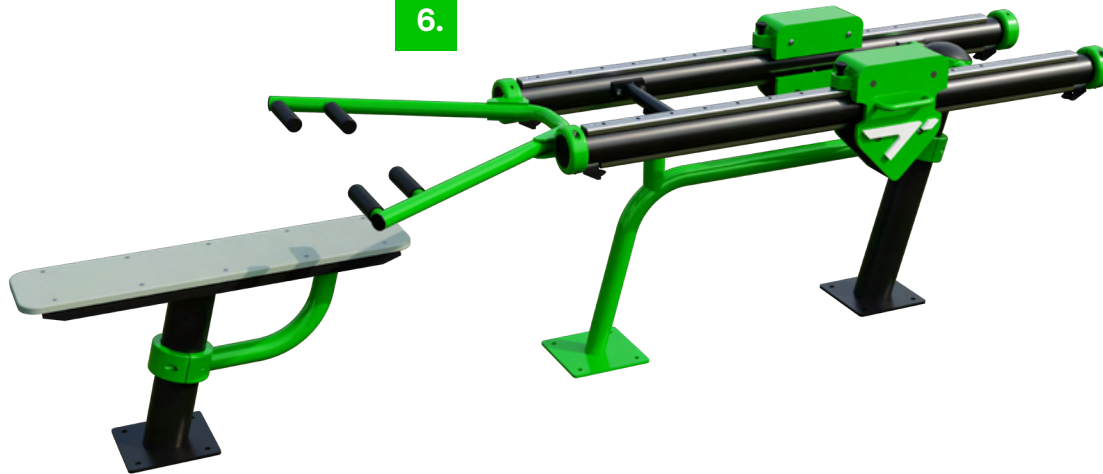

| | ID. | Product Name | Certificate | Age Group | Capacity | Difficulty level | Concrete volume | Anchoring options | Critical fall height |
|----|---------|--------------|----------------------|------------|----------|------------------|-----------------------|-------------------|----------------------|
| 4. | 1-1-321 | Biceps Curl | EN 16630, ASTM F3101 | 14 + years | 1 person | - | 14.12 ft ³ | Surface mounted | - |
| 5. | 1-1-320 | Low Row | EN 16630, ASTM F3101 | 14 + years | 1 person | - | 35.31 ft ³ | Surface mounted | - |
| 6. | 1-1-020 | Bench Press | EN 16630, ASTM F3101 | 14 + years | 1 person | - | 42.38 ft ³ | Surface mounted | 19.7" |

SOCCER SPECIFIC

For the full range of Soccer Specific

- < click on the QR code, or
- < scan with your mobile device





BESTRONG's exclusive, football-specific equipment adds a new dimension to the sport's training culture. Developed with input from a wide range of professional athletes, our carefully designed equipment is intended to enhance athletes' skill development and overall performance. Whether it's for stabilization or mobilization, strength training, or simple warm-ups, our sport-specific equipment can meet the needs of various sports and performance levels. Our outdoor-specific solutions are crafted with extreme precision to fulfill your high-quality training requirements.

1.



2.



3.



| | ID. | Product Name | Certificate | Age Group | Capacity | Difficulty level | Concrete volume | Anchoring options | Critical fall height |
|----|---------|------------------------------|----------------------|------------|----------|------------------|-----------------------|----------------------|----------------------|
| 1. | 1-1-184 | Nordic Hamstring Station Pro | EN 16630, ASTM F3101 | 14 + years | 1 person | Medium | 14,83 ft ³ | In-ground or surface | 13.03" |
| 2. | 1-1-162 | Glute-Ham Developer Pro | EN 16630, ASTM F3101 | 14 + years | 1 person | Medium | 17,66 ft ³ | In-ground or surface | 47.87" |
| 3. | 1-1-161 | Balance Board Pro | EN 16630, ASTM F3101 | 14 + years | 1 person | Medium | 7,06 ft ³ | In-ground or surface | 13.31" |

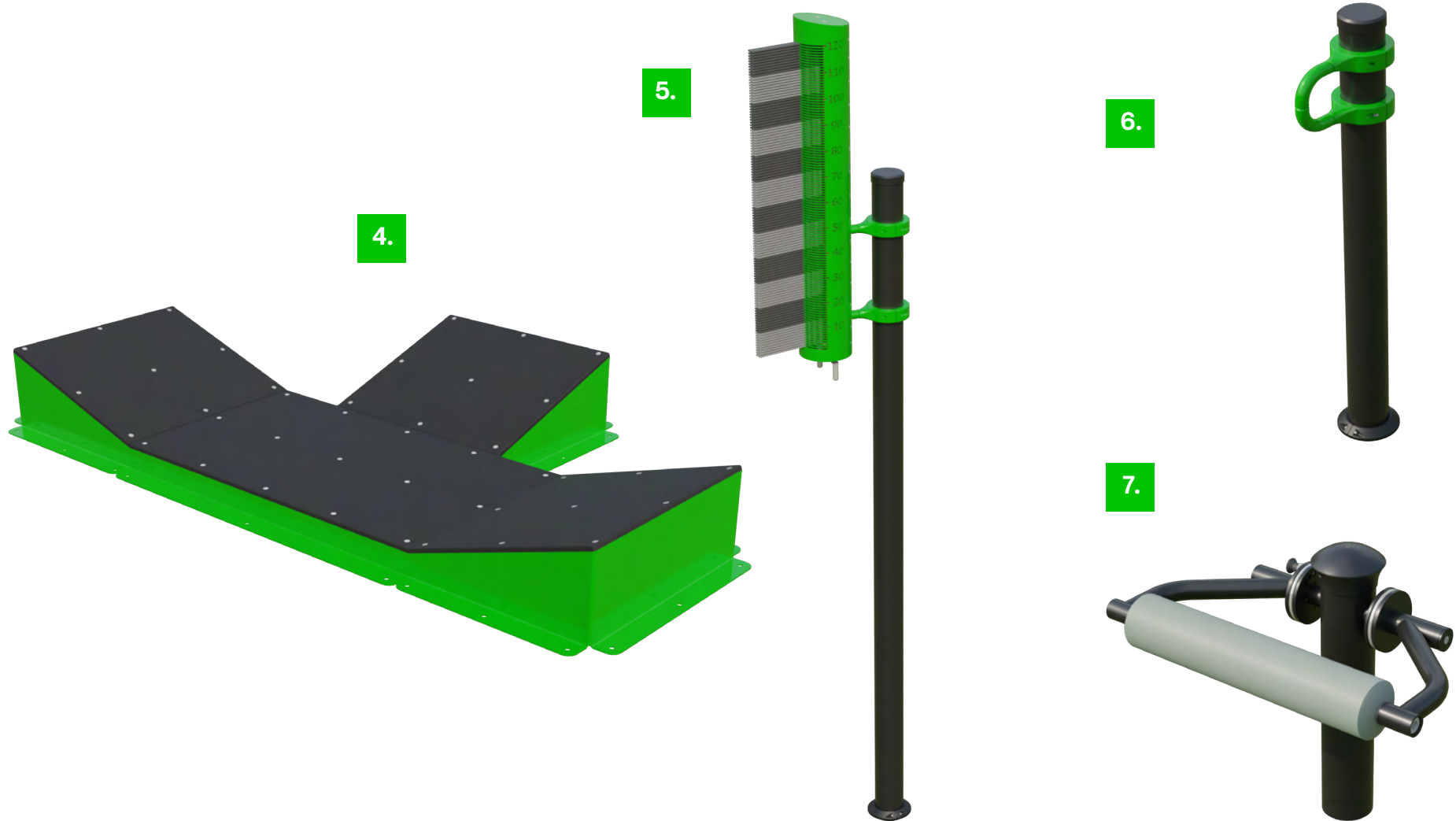

| | ID. | Product Name | Certificate | Age Group | Capacity | Difficulty level | Concrete volume | Anchoring options | Critical fall height |
|----|---------|----------------------------|----------------------|------------|----------|------------------|-----------------|----------------------|----------------------|
| 4. | 1-1-186 | Lateral Plyo Box Pro | EN 16630, ASTM F3101 | 14 + years | 1 person | Easy | 49,44 ft³ | In-ground or surface | 11.93" |
| 5. | 1-1-189 | Vertec Pro | EN 16630, ASTM F3101 | 14 + years | 1 person | Easy | 17,66 ft³ | In-ground or surface | - |
| 6. | 1-1-164 | Resistance Band Anchor Pro | EN 16630, ASTM F3101 | 14 + years | 1 person | Easy | 17,65 ft³ | In-ground or surface | - |
| 7. | 1-1-163 | Split Squat Stand Pro | EN 16630, ASTM F3101 | 14 + years | 1 person | Easy | 17,66 ft³ | In-ground or surface | 26.1" |

ACCESSORIES



| ID. | Product Name | Height | Width | Description | |
|-----|--------------|---------------|--------|-------------|------------------------------------------------------------------------------------------------------------------------------------------|
| 1. | 1-0-001 | Bicycle Rack | 32.91" | 30.70" | Our outdoor bike racks are made with a bent steel tube structure and a durable powder coated finish. |
| 2. | 1-0-002 | Waste Bin | 39.60" | 15.90" | Our outdoor waste bins are finished with a durable powder coating and have curved columns for greater stability. |
| 3. | 1-0-003 | Outdoor Bench | 39.76" | 68.38" | The frame of our outdoor benches is made of 114.3 x 2 mm tubing with a durable powder coating. The seat and back are made of WPC planks. |



4.

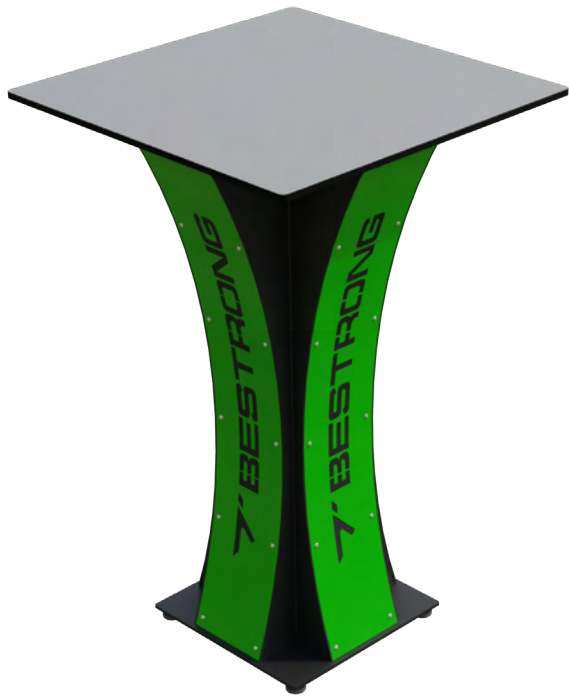

5.



6.

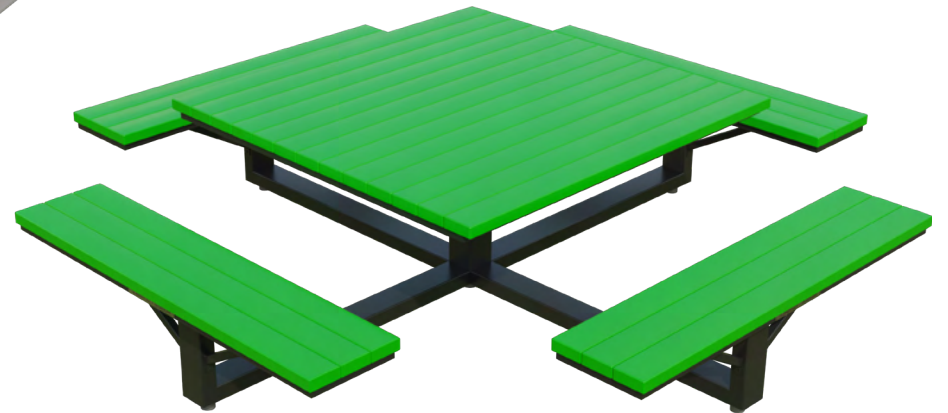

| ID. | Product Name | Height | Width | Description | |
|-----|--------------|-----------------------------|--------|-------------|-----------------------------------------------------------------------------------------------------|
| 4. | 1-0-008 | Outdoor Bar Table | 39.60" | 15.90" | Aesthetically pleasing and robust bar table, perfect for enhancing outdoor social spaces. |
| 5. | 1-0-005 | Bench with Integrated Table | 27.55" | 78.74" | Functional outdoor bench with a durable metal frame and attached table, suited for outdoor seating. |
| 6. | 1-0-006 | Parkside Table Bench | 31.49" | 116.53" | Elegant outdoor bench with a powder-coated frame and WPC trim, featuring a convenient table. |



7.



8.

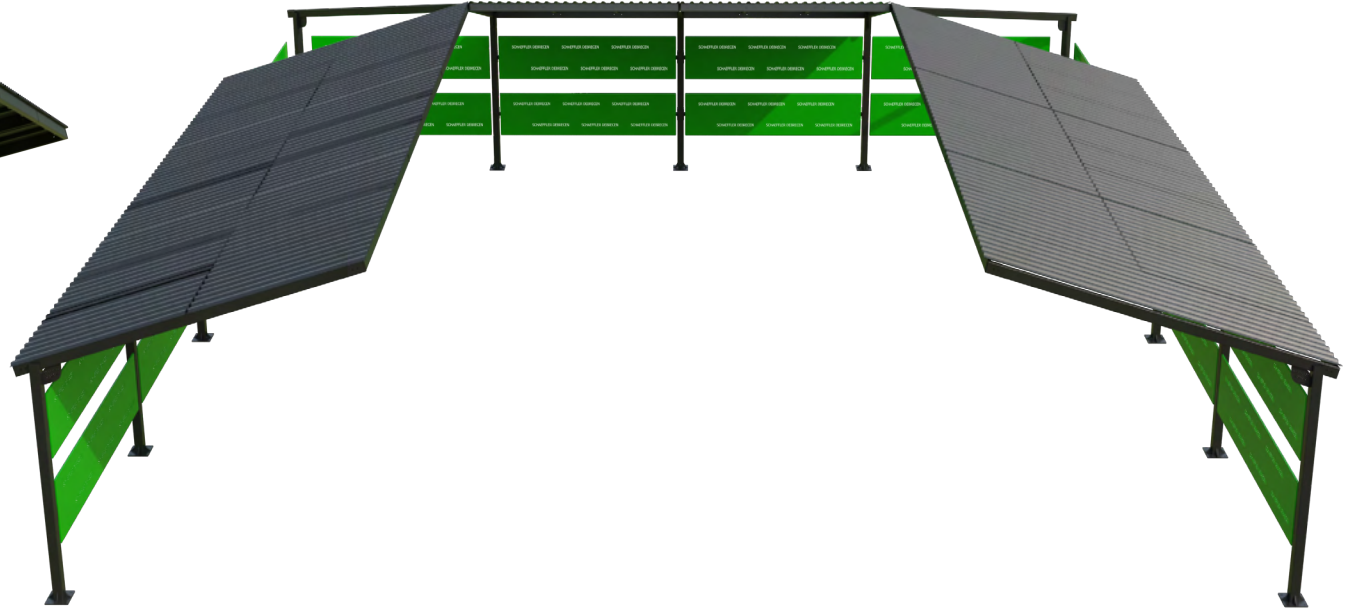

| | ID. | Product Name | Height | Width | Description |
|----|---------|------------------------|--------|--------|-----------------------------------------------------------------------------------------------------|
| 7. | 1-0-009 | Modern Outdoor Lounge | 96.85" | 30.70" | Sleek outdoor lounge with metal support and a solid roof, designed to be a stylish outdoor shelter. |
| 8. | 1-0-010 | U-Shape Outdoor Lounge | 39.60" | 15.90" | Contemporary metal U-shaped lounge, creating a fashionable and durable outdoor shelter. |

SPORTING KANSAS CITY



ARENAS

For the full range of Arenas

- < click on the QR code, or
- < scan with your mobile device



1.



2.



3.



4.

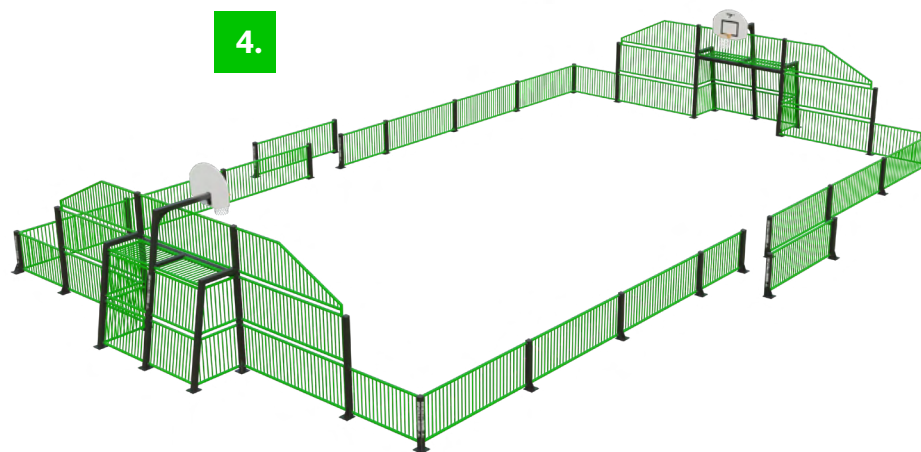

| ID. | Product Name | Type | Age Group | Fence height | Length | Width | Height | Total area | Anchoring options | Anti-corrosion possibility |
|-----|----------------------|------|-----------|--------------|-----------|-----------|-----------|------------|-------------------|----------------------------|
| 1. | MUGA Goal End M | MUGA | 3 + years | 9'-10.11" | 30'-7.72" | 7'-11.44" | 12'-4.47" | - | Surface mounted | Galvanized |
| 2. | MUGA Basketball Hoop | MUGA | 3 + years | - | 6'-3.79" | 3'-10.46" | 12'-4.98" | - | Surface mounted | Galvanized |
| 3. | MUGA Goal End S | MUGA | 3 + years | 9'-10.11" | 10'-6.77" | 7'-11.49" | 12'-4.47" | - | Surface mounted | Galvanized |
| 4. | Athens | MUGA | 3 + years | 3'-3.71" | 77'-5.84" | 50'-3.94" | 12'-4.47" | 3900 ft' | Surface mounted | Galvanized |



5.

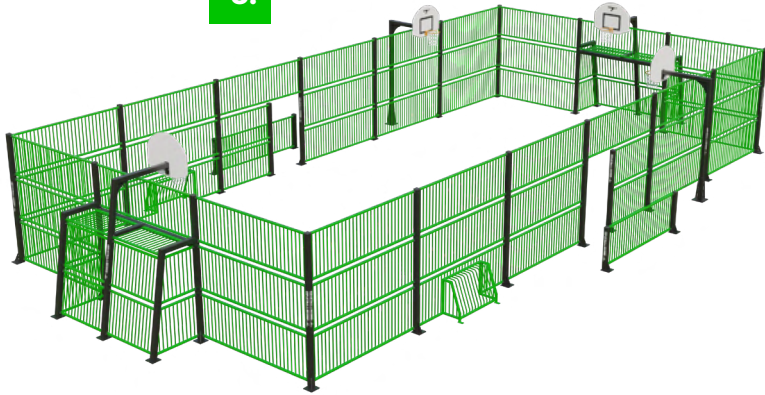

6.

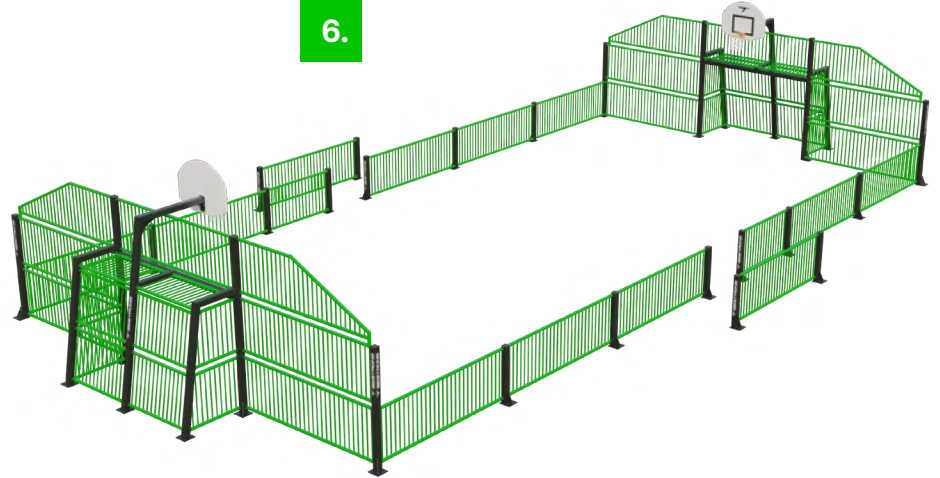

7.

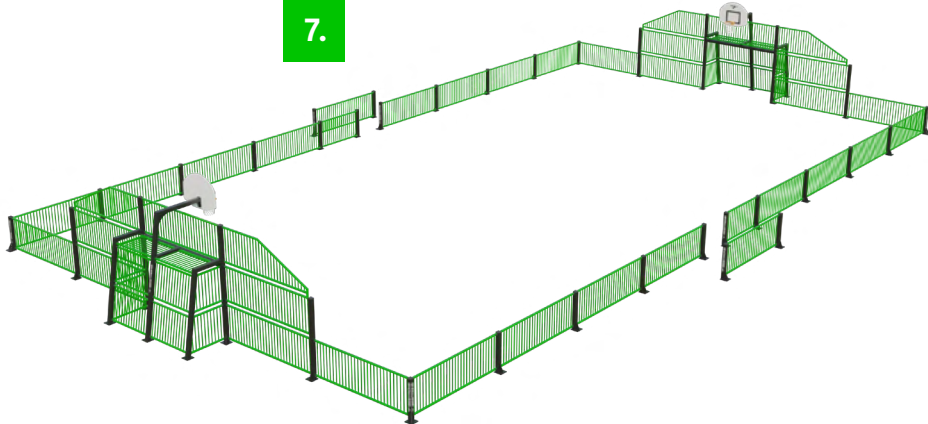

8.

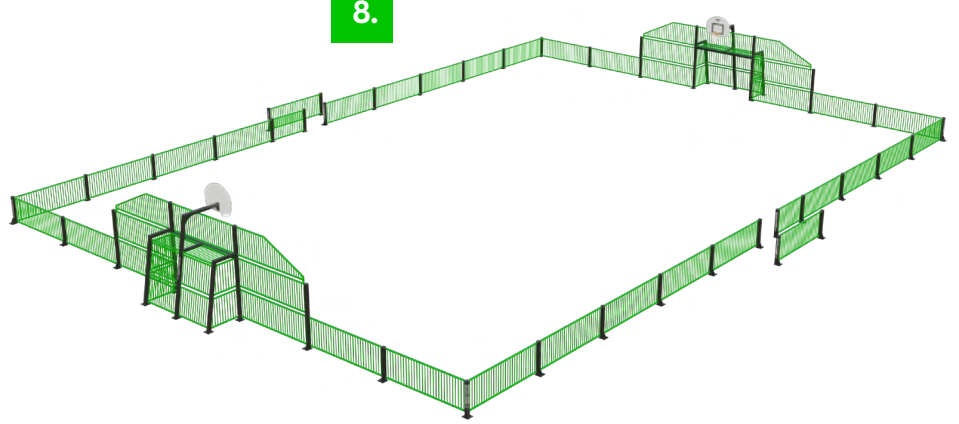

| ID. | Product Name | Type | Age Group | Fence height | Length | Width | Height | Total area | Anchoring options | Anti-corrosion possibility |
|-----|--------------|------|-----------|--------------|------------|------------|-----------|------------|-------------------|----------------------------|
| 5. | Alexandria | MUGA | 3 + years | 9'-10.11" | 67'-7.73" | 38'-6.20" | 12'-4.47" | 2605 ft' | Surface mounted | Galvanized |
| 6. | Pompeii | MUGA | 3 + years | 3'-3.71" | 67'-7.73" | 38'-6.20" | 12'-4.47" | 2605 ft' | Surface mounted | Galvanized |
| 7. | Syracuse | MUGA | 3 + years | 3'-3.71" | 97'-2,07" | 58'-2.43" | 12'-4.47" | 5656 ft' | Surface mounted | Galvanized |
| 8. | Verona | MUGA | 3 + years | 3'-3.71" | 107'-0.18" | 77'-10.62" | 12'-4.47" | 8335 ft' | Surface mounted | Galvanized |



9.

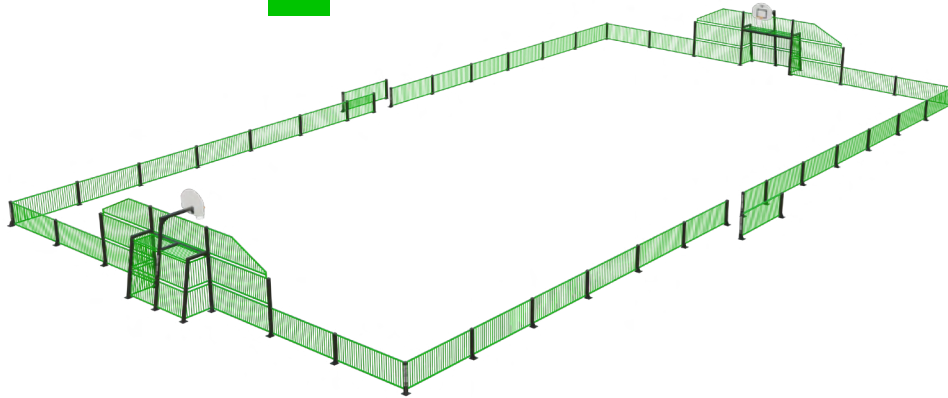

10.

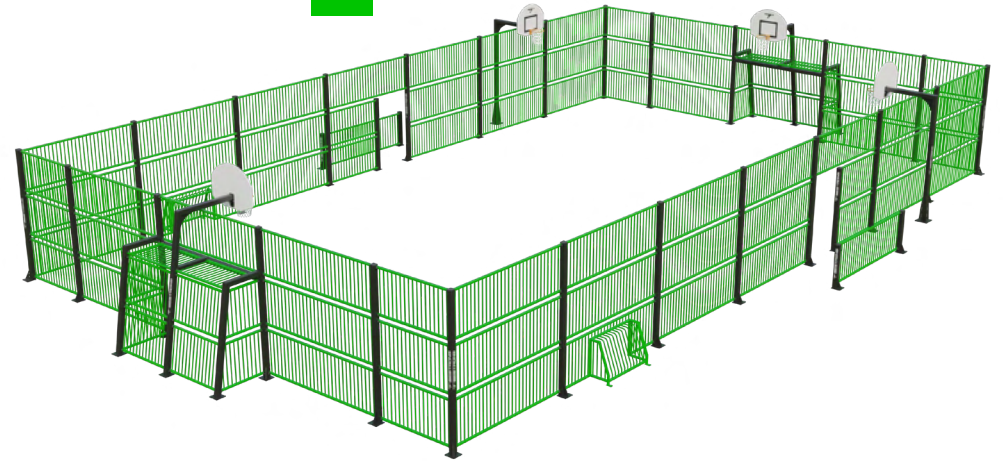

11.

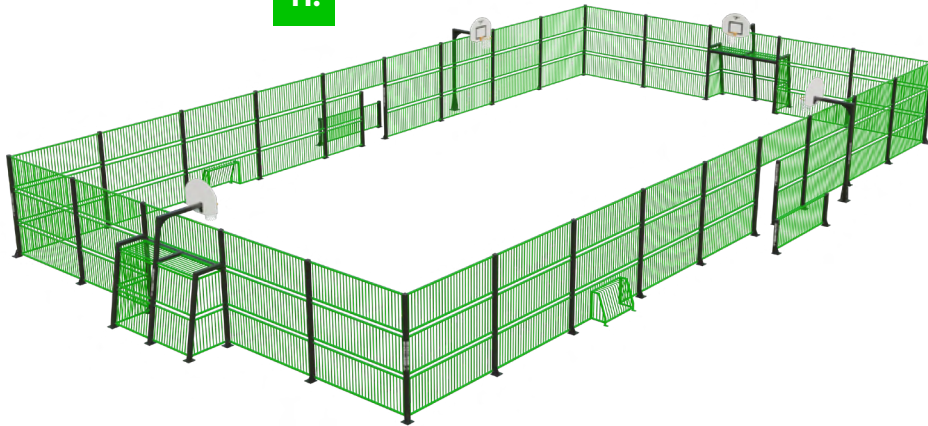

12.

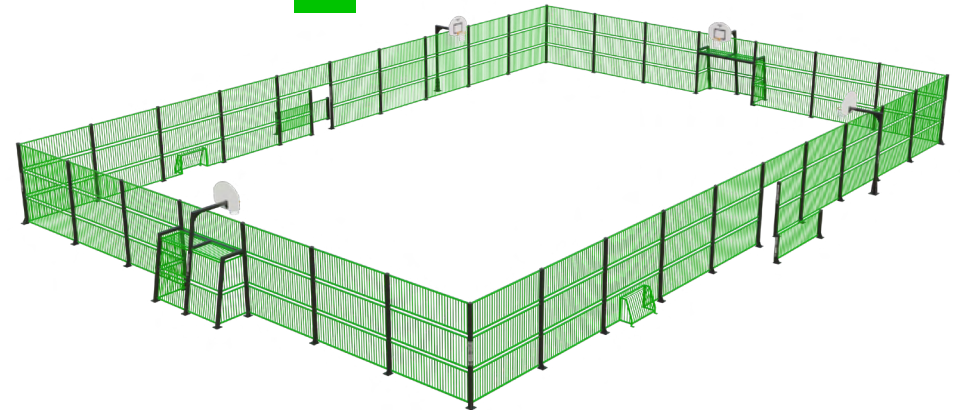

| ID. | Product Name | Type | Age Group | Fence height | Length | Width | Height | Total area | Anchoring options | Anti-corrosion possibility |
|-----|----------------|------|-----------|--------------|------------|------------|-----------|------------|-------------------|----------------------------|
| 9. | Rome | MUGA | 3 + years | 3'-3.71" | 136'-6.51" | 77'-10.65" | 12'-4.47" | 10635 ft' | Surface mounted | Galvanized |
| 10. | Constantinople | MUGA | 3 + years | 9'-10.11" | 77'-5.84" | 50'-3.94" | 12'-4.47" | 3900 ft' | Surface mounted | Galvanized |
| 11. | Pergamon | MUGA | 3 + years | 9'-10.11" | 97'-2.07" | 58'-2.43" | 12'-4.47" | 5656 ft' | Surface mounted | Galvanized |
| 12. | Merida | MUGA | 3 + years | 9'-10.11" | 107'-0.18" | 77'-10.65" | 12'-4.47" | 8335 ft' | Surface mounted | Galvanized |



13.

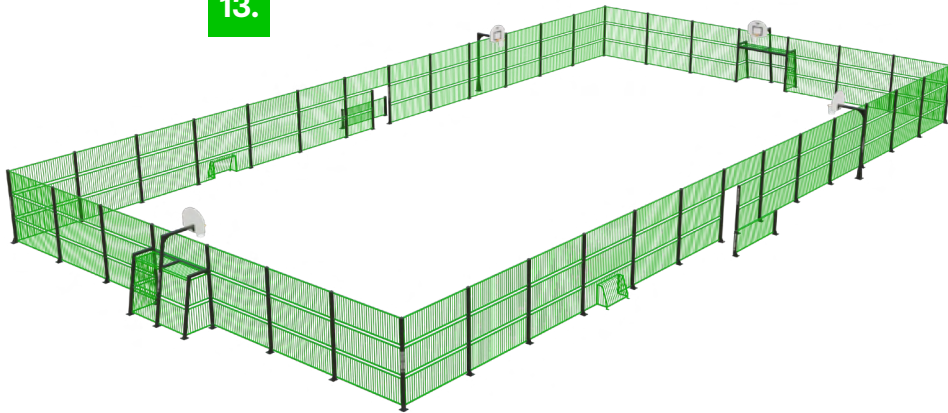

14.

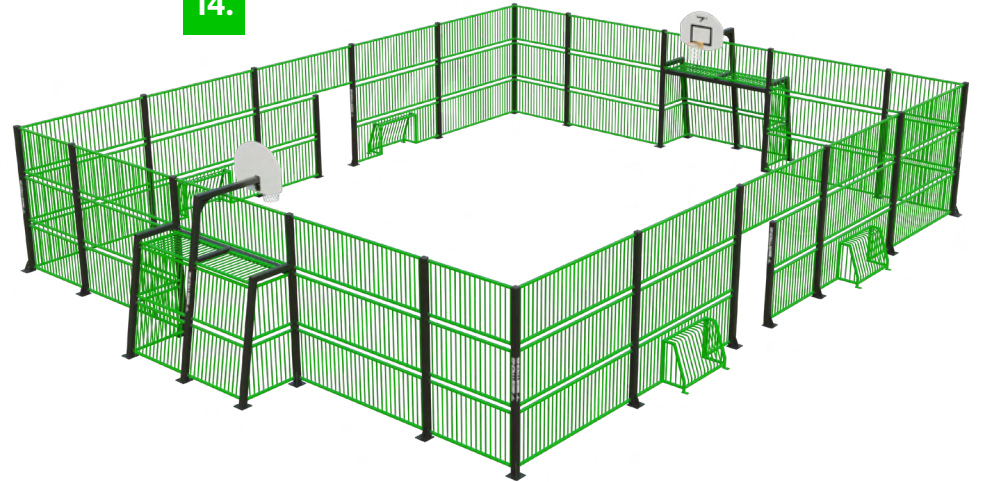

15.

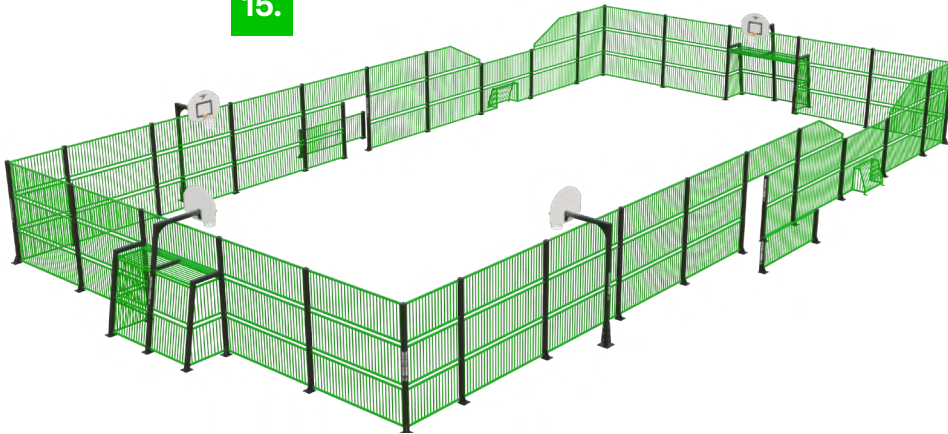

16.

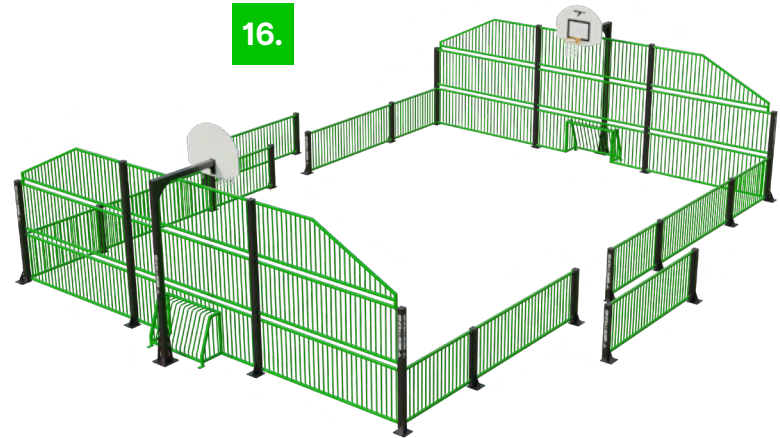

| ID. | Product Name | Type | Age Group | Fence height | Length | Width | Height | Total area | Anchoring options | Anti-corrosion possibility |
|-----|--------------|------|-----------|--------------|------------|------------|-----------|------------|-------------------|----------------------------|
| 13. | Palmyra | MUGA | 3 + years | 9'-10.11" | 136'-6.51" | 77'-10.65" | 12'-4.47" | 10635 ft' | Surface mounted | Galvanized |
| 14. | Aquincum | MUGA | 3 + years | 9'-10.11" | 57'-9.62" | 44'-7.19" | 12'-4.47" | 2578 ft' | Surface mounted | Galvanized |
| 15. | Delphi | MUGA | 3 + years | 9'-10.11" | 99'-1.69" | 58'-2.43" | 12'-4.47" | 5770 ft' | Surface mounted | Galvanized |
| 16. | Pompeii Mini | MUGA | 3 + years | 3'-3.71" | 46'-7.84" | 38'-6.20" | 12'-4.47" | 1797 ft' | Surface mounted | Galvanized |



17.

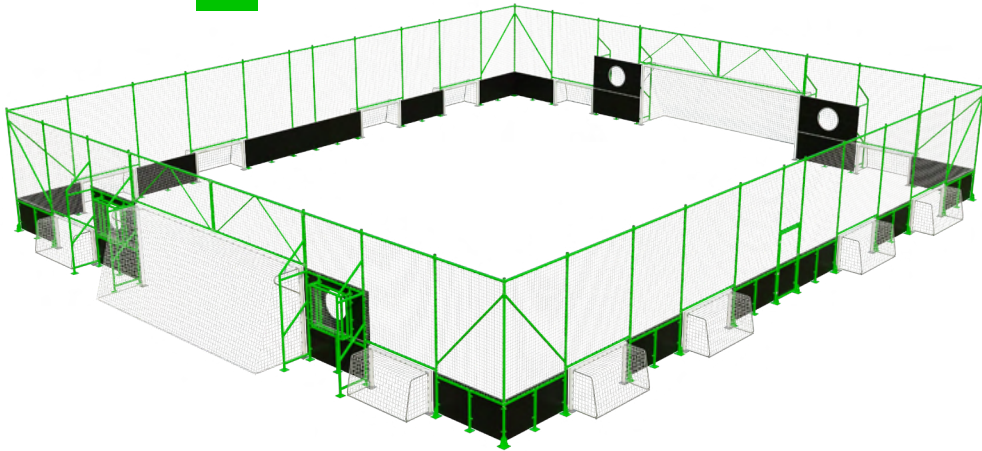

18.



19.



20.



| ID. | Product Name | Type | Age Group | Fence height | Length | Width | Height | Total area | Anchoring options | Anti-corrosion possibility |
|-----|-------------------|----------------|-----------|--------------|-----------|------------|----------|------------|-------------------|----------------------------|
| 17. | 1-1-189 SKC ARENA | FOOTBALL ARENA | 3 + years | 6'-6.74" | 31'-4.52" | 26'-10.05" | 6'-7.02" | 842 ft' | Surface mounted | Galvanized |
| 18. | 4-3-035 Octagon | PANNA | 3 + years | 3'-3.71" | 28'-1.11" | 24'-11.37" | 3'-3.65" | 676 ft' | Surface mounted | Galvanized |
| 19. | 4-3-036 Ellipse | PANNA | 3 + years | 6'-6.74" | 31'-4.52" | 26'-10.05" | 6'-7.02" | 842 ft' | Surface mounted | Galvanized |
| 20. | 4-3-037 Hexagon | PANNA | 3 + years | 3'-3.71" | 20'-4.94" | 21'-1.02" | 3'-3.65" | 430 ft' | Surface mounted | Galvanized |

PADEL





Padel was invented in 1969 in Mexico. Today it is a highly popular sport in Spain and Latin America and is rapidly gaining popularity in other parts of the world: there are over 25 million active padel players in over 110 countries. Come and join one of the world's fastest-growing sports with BeStrong. Starting in the fourth quarter of 2024, we will introduce our state-of-the-art padel courts in our portfolio. Our courts are carefully designed, and made from exceptional and durable materials, ensuring safety and security in any weather conditions. Our padel courts are the result of a combination of aesthetics, innovation, and a high-tech manufacturing process using only the highest-quality materials. Padel is a unique and exciting sport that offers a range of physical and social benefits for players of all ages and skill levels.

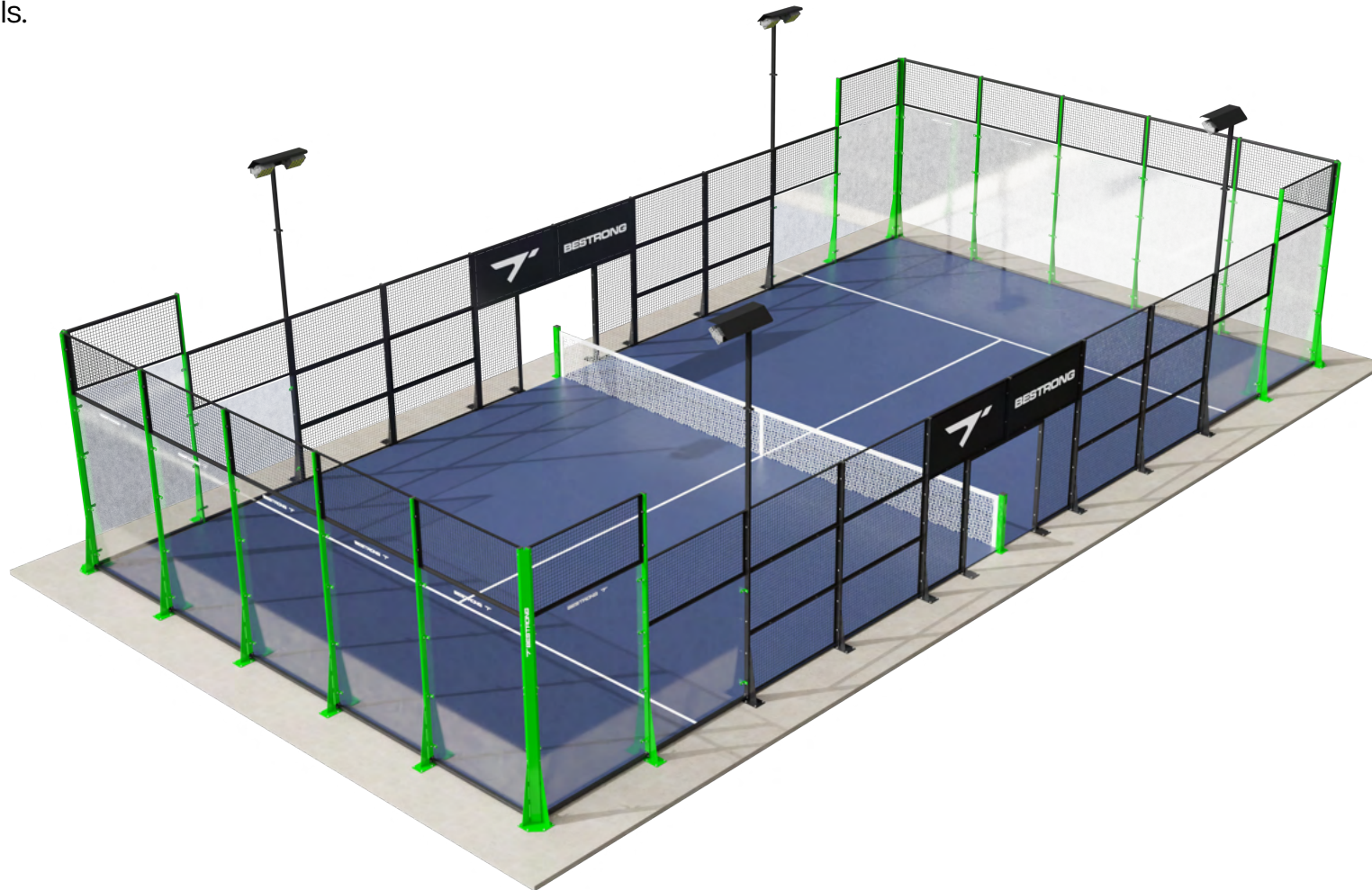

VIEW IT IN 3D & AR



Users can now explore our sports parks not only through conventional images but also in 3D and within an augmented reality (AR) environment. Through AR, you can not only obtain a close-up view of the finest details and dimensions of our sports equipment but also interactively zoom into any location in real-time using your mobile device's camera to view 3D renditions of our designed collections and assemblies. Our innovation enables you to enter, experiment with, and explore your future sports park within a virtual environment of your choosing. Try our new AR functionality today and discover the most suitable sports park for you in a truly unique experience.



DESIGN YOUR FITNESS PARK

Full support
for your needs

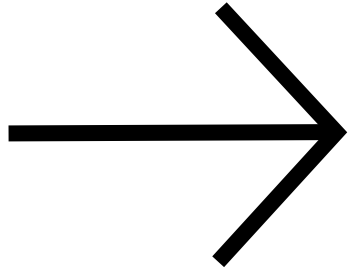

BESTRONG 3D PLANNER is a user-friendly 3D software that enables you to design and visualize your very own outdoor fitness park with remarkable precision. Our complete array of sports equipment and accessories is at your disposal for custom design. High-quality 3D models can be viewed from various angles, freely combined, and colorized using the software. Craft your unique sports park with BESTRONG 3D PLANNER!

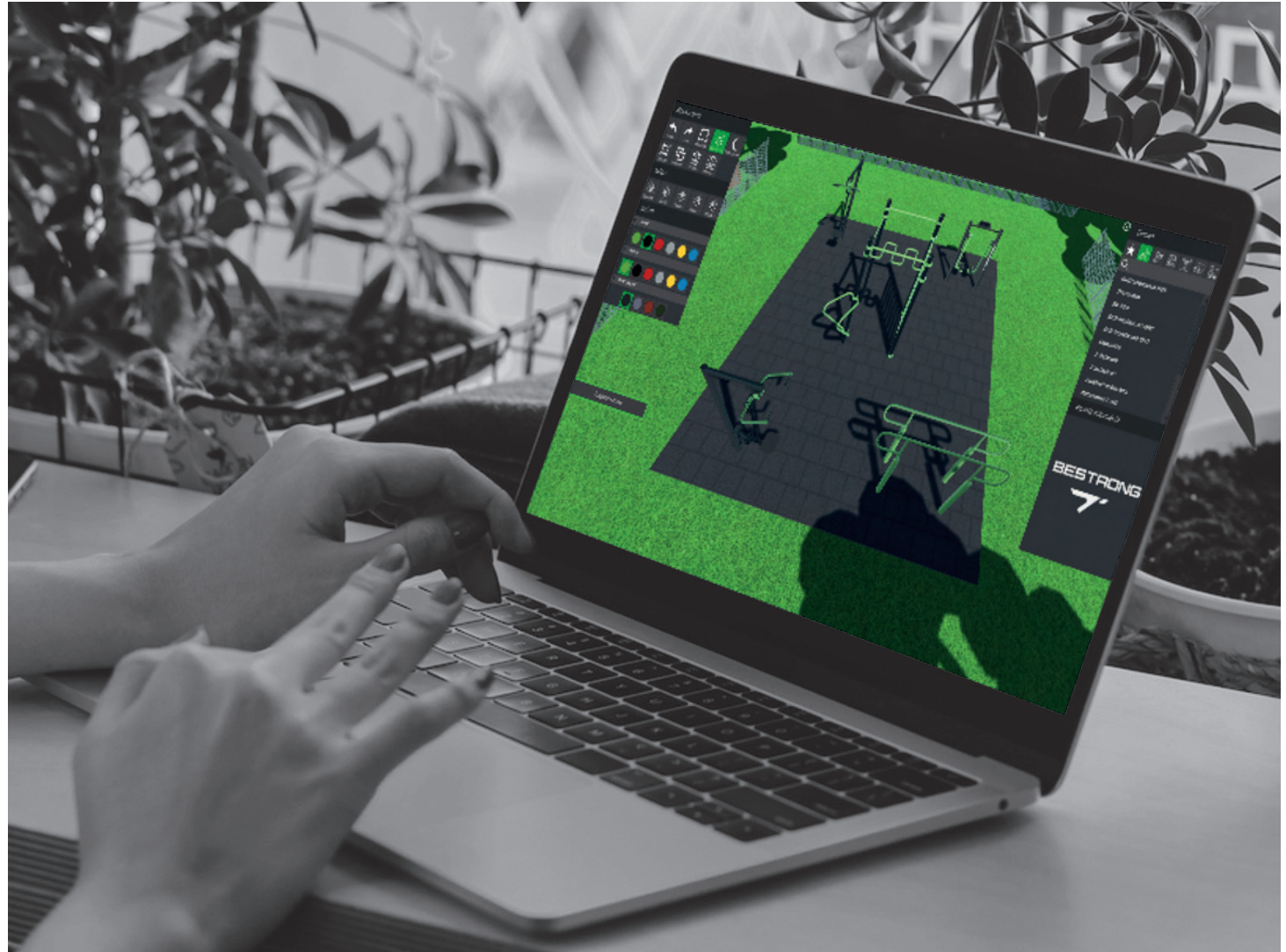

CRAFTSMANSHIP



At our manufacturing facility, we employ state-of-the-art technology such as laser cutting, edge bending, and CNC machining to produce our sports equipment. Skilled technicians oversee welding operations with rigorous quality control.

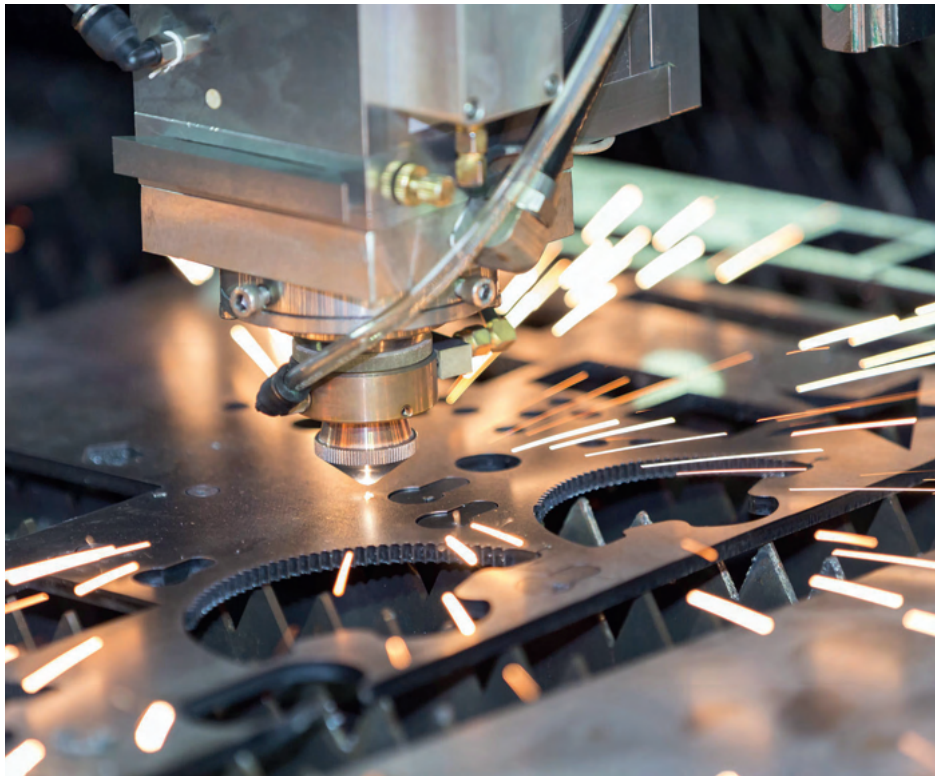
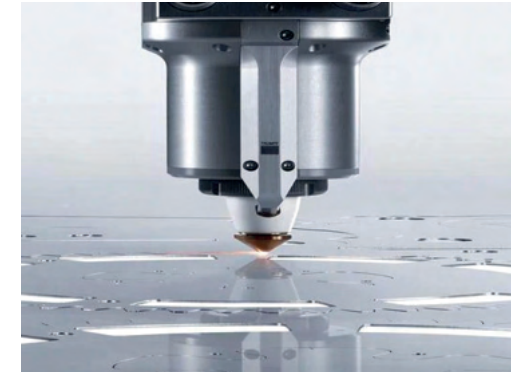

The majority of surface treatments are conducted in-house. In addition to our shot blasting chambers, our facility houses a high-capacity powder coating unit and a solvent paint booth that complement the manufacturing process. We ensure corrosion protection through methods such as hot-dip galvanizing or EPD technology, a widely-used process in the automotive industry worldwide.

INNOVATIVE



MANUFACTURING

Function

Aesthetic

Safety

Quality



PRODUCTION

Our foremost priority is to ensure that our products meet the highest standards of functionality, aesthetics, and safety. To achieve this, we maintain meticulous oversight of our manufacturing and quality control processes, which adhere to the MSZ EN ISO 9001:2015 standard, audited by TÜV SÜD.

Environmental preservation holds significant importance for us, and as such, our production and installation processes are aligned with the EN ISO 14001:2015 environmental management system standard.

MATERIAL SPECIFICATION



At the end of the arms, the handle is rubber-coated for a more comfortable and secure grip.



The seats and backrests are made of strong HDPE material. Which is fully heat, moisture and UV resistant.

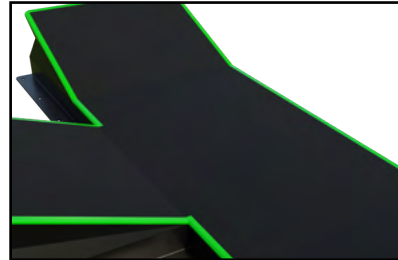

The top surface of the Lateral Plyo Box is covered with the highest quality non-slip HDPE.



The bumpers of the devices are made of durable rubber material.

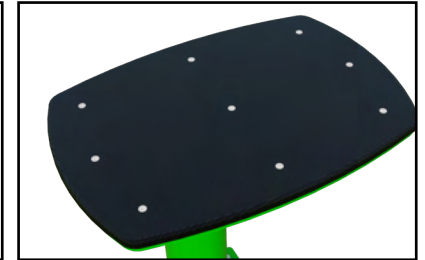

The top surface of the device is covered with the highest quality non-slip HDPE.

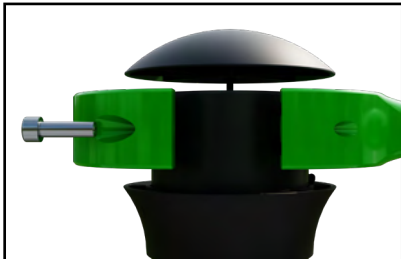

The clamp system allows for easy assembly and extreme stability.



The top surface of the Balance Board Pro is covered with the highest quality non-slip HDPE.

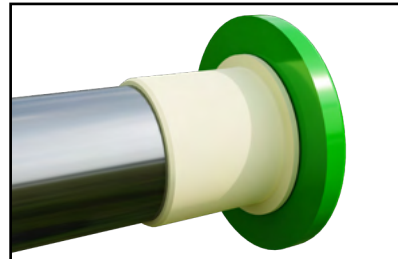

The recreational and cardio devices are fitted with composite bearings that are weather-resistant. The bearing does not require regular maintenance.



The rope is fully heat, moisture and UV resistant.



The ends of the bars and posts are sealed with injection-moulded plastic caps.



Steel ropes with a 0.63" mm diameter, galvanized and sheathed in nylon, are joined using connectors made of plastic. These ropes are UV radiation, abrasion, and rot-resistant.



The device is equipped with an ergonomic non-slip HDPE phone holder for convenience.



The footrests are made of premium quality non-slip HDPE with a high wear resistance.

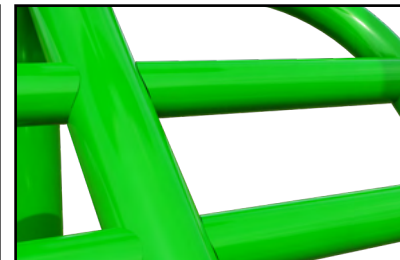

The element is made of high quality S235 steel, which has been cleaned via sandblasting. A corrosion resistant powder coating finish is then applied. Also available with galvanized surface for even greater protection and longevity!

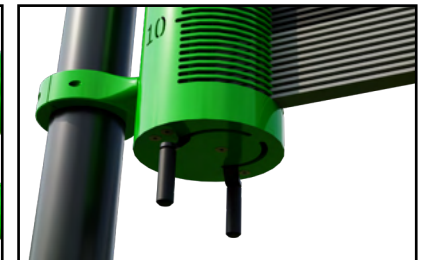

The internal structure has 120 moveable plastic "bars". The levers are rubber-coated for a more comfortable grip and to prevent head injuries

WARRANTY



15-year limited warranty on failures of steel elements and steel components due to material or manufacturing defects and **25 years** on structural integrity.

10-year limited warranty for defects in plastic HDPE components due to material or workmanship and **5 years** for defects in all other plastic components (except colour fading).

5-year limited warranty for significant corrosion of painted metal parts that inhibit the use of the equipment and **10 years** warranty for galvanized and cataphoretic painted steel parts.

3-year limited warranty on failure of all rubber based parts and **1 year** on rubber bumpers.

2-year limited warranty on powder coated paint integrity.

2-year limited warranty for bearings of moving elements.

For the full range of Warranty

- < click on the QR code, or
- < scan with your mobile device



CONTACTS

BESTRONG USA, INC.



@bestrongworld



@bestrongworld



BeStrong USA



usa.bestrong.com



**182 S. Young Street,
Ormond Beach, FL, 32174, USA**



usa@bestrong.com





7. BESTRONG